



USER MANUAL

Livinox Malaysia Sdn Bhd (1089457-U)
No 32A, Jalan Teknologi 3/3A,
Taman Sains Selangor 1, Kota Damansara,
47810 Petaling Jaya, Selangor.

www.livinox.my



Careline
+603-6150 7810

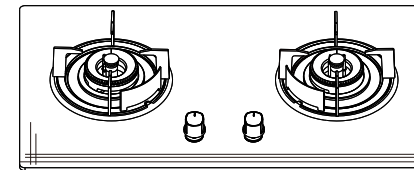

LGH-218 2B-FG

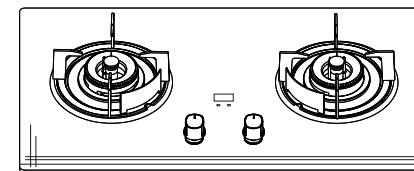

LGH-VOLCANO 2B-FG

Dear Consumer,
 Thank you for your purchase of our products. To ensure you use the appliance in the best effect, please read this instruction manual with care before using and save it for future reference.

 **The manufacturer declines all responsibility for damage to persons or things caused by non observance of the above prescriptions or by interference with any part of the appliance or by the use of non original spares**



CONTENT

SPECIAL PRECAUTIONS	1
PARTS IDENTIFICATION	3
INSTALLATION	4
DIRECTION FOR USE	5
PRODUCT DIMENSIONS	6
CLEANING AND MAINTENANCE	6
DESCRIPTION OF TIMER OPERATION	7
i-SYNC HOB UM OPETATION	8
TROUBLE-SHOOTING GUIDE.....	9

(1) SPECIAL PRECAUTIONS







To avoid any danger and loss when using the hob, we make below mark. Below is all about special precautions. Please pay full attention to it and operate in a right way.

■ Marks are identified by different danger and loss level

 WARNING If ignoring this mark and operate improperly, it may lead die, hurt or fire.
 ATTENTION If ignoring this mark and operate improperly, it may lead die, hurt or fire.
ADVICE In order to be safe and convenient when using it, please kindly understand this content.

■ Marks for ATTENTION

					
BURNING	MUST DO	FORBIDDANCE	NO FIRE	NO TOUCH	NO DISASSEMBLY

 DANGER	
<p> When gas leakage</p> <ol style="list-style-type: none"> 1.stop using the hob immediately. 2.turn off the gas valve 3.open windows and doors 4.contact the local gas company <p style="text-align: center;"></p>	<p> If case of gas leakage</p> <ul style="list-style-type: none"> *do not ignite any fire. *do not turn on any electrical appliance *do not touch power plug *do not use telephone nearby <p style="text-align: center;">Flame spark will lead fire. </p>
<p> When feeling strange burning, or smell gas, or in case of earthquake, fire, please do as below:</p> <ol style="list-style-type: none"> 1.turn the knob to OFF position 2.turn off the gas valve 3.contact our after-sale service dept. immediately <p style="text-align: center;">Above is to avoid fire or fault.</p>	<p> Please use the right type of gas according to the rating label.</p> <p style="text-align: center;">If use the gas other than that are appointed, it may leads gas cooker damage or even fire.</p>

! To install, repair, move a gas appliance, must be carried out by our service dept., or a registered gas installer. Otherwise, we will not take the responsibility for any damage.

! Any repair, disassembly must be carried out by registered technical people. Or else, it may leads fire or fault.

! Must use the specified gas pipe.

! Do not put any spray container nearby the hob. It may lead fire.

! Any easy-burned item like clothes, newspaper, coal oil, can not be put nearby the hob.

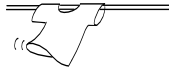

It may lead fire.



! Do not use coal oil, gas oil, or other easy-burning and explosive product nearby the hob.

It may lead fire.

! ATTENTION

! There should be space of at least 400mm height between the hob bottom and cupboard. And the space can not be sealed, with hole of diameter not less than 0.2 sq meter.

! There should be space between hob and items nearby. (not less than 150mm from the wall, 1mm from above)

! Gas container can not be put right below the hob. Gas pipe not more than 2 meters.

! The hob should be kept more than 1 meter away from the gas container. Gas pipe can not reach other part of the hob.

! To ensure the burner and trivet are put in the right place before using the hob.

! Keep the kitchen in ventilated situation. But do not let strong wind to below the burner directly.

! Do not touch the trivet and burner immediately after using it, because they're very hot.

! Turn the knob to OFF and turn off the gas valve after using. Remember to turn off the gas brake when you go out or go to sleep.

ADVICE

Check whether the gas pipe are in a good situation sometimes. The pipe should be changed for every two years.

(2) PARTS IDENTIFICATION

1.PARTS IDENTIFICATION

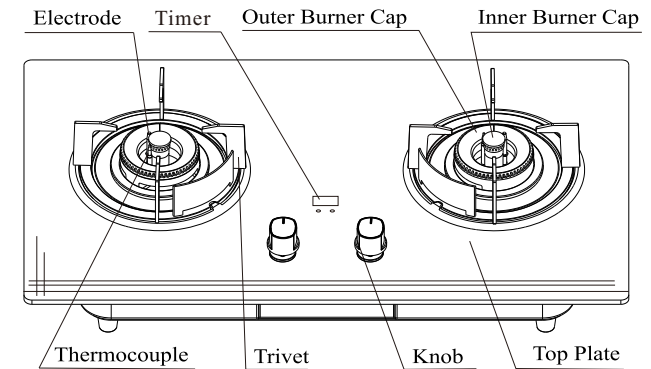

Remark: above is the built-in hob structure and part identification. Other type of hob can refer to above picture.

(3) INSTALLATION

1. Open holes in the cupboard:

Open holes in the cupboard with the instruction paper in the package. (see picture 3)

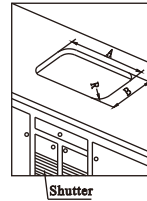

picture 3

2. Install the gas pipe

A. If to use plastic tube: put in the airproof caution, connect the tube and hob connector, fasten the clip. (see picture 4)

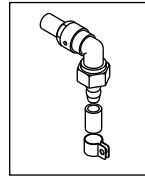

picture 4

B. If to use metal tube: put in the airproof caution, fasten the nuts on the connection. (See picture 5)

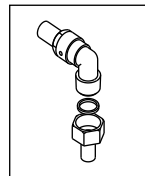

picture 5

3. Put the hob in the right hole on the cupboard, check whether it's installed in a balance.

The bottom of top plate should be stuck with seal packing.

4. check leakage: turn on the gas valve. check whether with soap water there's leakage in the connection. If any leakage, it needs to be reinstalled.(there'll be air bubble for leakage).

(4) DIRECTION FOR USE

Ignition safety hob have flame failure protect device. When accident flame failure occurs by wind or spilled liquid, the flame failure protect device will shut the gas supply automatically.

- 1.Insert battery properly into battery case located at bottom of hob.
- 2.Turn on the gas valve .
- 3.Turn the knob left until it reaches the full on position (about 90 degree anti-clockwise).
Having heard the sound of continuous sparks, simultaneously the burner will be ignited.
Keep pushing the knob for 5-8 seconds before taking your hand.
- 4.You can choose five different fame by turning the hob.
- 5.Turn the hob to OFF by clockwise. After continuous sound,the gas supply will be cut-off,and flame out.

NOTE:

1. For the newly installed hob or hob not used for some time, it may fail to ignite at first time, because there's air in the tube. You can repeat until the air is exhausted out, then it can work.
2. If there's yellowish flame or uneven flame, adjust the damper at the bottom to get a normal flame.

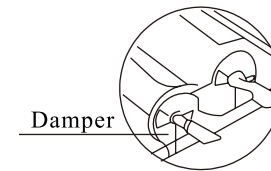

picture 6

(5) PRODUCT DIMENSIONS

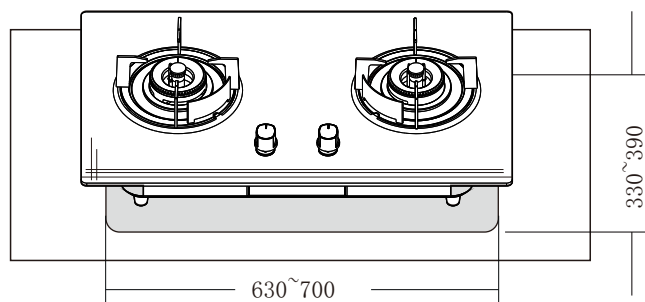

(6) CLEANING AND MAINTENANCE

To ensure the hob can be used properly, the clearance and maintenance is necessary. Keep the hole of burner cap and gas flow not to be stuff. Keep the electrode and thermocouple clear. Before clearing and maintenance, shut off the gas supply and let all parts cold.

Wash burner caps, burner, electrode, thermocouple and trivets with mild detergent when they're dirty. Then put them back to their proper position. Use steel wire to clear the dirt in the burner cap. When the top plate get dirty, never use any sharp or hard brush but only sponge brush with mild detergent to clean them.

To check the gas tube often, and change new gas tube for every two years.

(7) DESCRIPTION OF TIMER OPERATION

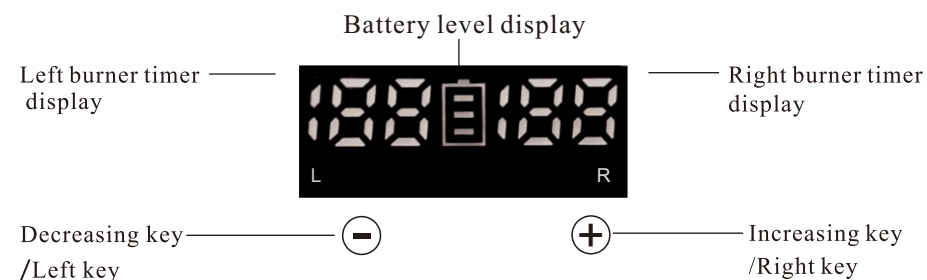

Power On:

- After the appliance is connected to power, the controller automatically enters standby mode, and the display screen shows no information.

Timer Operation:

- Left Knob Timer Setting: Press and hold the "-" key for 1.5 seconds. The buzzer will sound once, indicating entry into the timer setting interface. The screen will display "15" and blink. Adjust the time (in minutes) by gently touching the "-" key. If there is no operation within 5 seconds, the current setting will be saved automatically.
- Right Knob Timer Setting: Press and hold the "+" key for 1.5 seconds. The buzzer will sound once, indicating entry into the timer setting interface. The screen will display "15" and blink. Adjust the time (in minutes) by gently touching the "+" key. If there is no operation within 5 seconds, the current setting will be saved automatically.
- The timer setting range is 0-180 minutes and can be set cyclically. Pressing and holding the "-" or "+" key without releasing can quickly adjust the timer.

Cancel Timer:

- In the timer operating state, pressing and holding both the "-" and "+" keys can cancel the timer settings for all burners;
- in the dual-side timer operating state, to cancel the timer for a single burner, press and hold the timer key for that burner, adjust the time to 0 minutes, and wait for 5 seconds to cancel the timer for that burner.

Screen Saver Mode:

- In timer mode, if there is no operation for 10 seconds, the screen will enter screen saver mode and the display will turn off. Touching any key will restore the display. One minute before the timer ends, the screen will automatically light up and start a countdown. After the countdown ends, a valve closing signal is sent, the buzzer sounds three times, the screen turns off and powers down, and the appliance enters sleep mode 20 seconds later.

Low Voltage Alarm:

- Each time the timer setting is accessed, if the battery voltage is below 1.95±0.1V, the battery icon will display one bar and blink, and the digital tube will display "E2:E2," indicating low battery voltage. The appliance will then enter sleep mode. In low voltage mode, the pulse ignition function can still be used, but timer operations are prohibited.

Low Voltage Alarm Removal:

- Replace the batteries to remove the low voltage alarm.

Self-Check Function:

- Within 25 seconds of power-on, pressing and holding the "-" and "+" keys for 2 seconds will initiate the self-check function. After 5 seconds, the system will sequentially turn off the left and right burners to complete the self-check process.

(8) i-SYNC HOB UM OPETATION

i-Sync Function

- Ensure the range hood is powered on before activating the i-Sync function on the hob.
- Refer to the range hood manual for specific instructions on enabling pairing mode.
- When the hood enters pairing mode, press and rotate the left or right knob counterclockwise to initiate the ignition process.
- The hob will begin pairing, and once the hood's AI icon stops flashing, the fan will start operating, indicating a successful connection.
- If pairing fails, turn off the hob and repeat the steps until pairing is successful.
- When the hob is turned off, the hood will automatically enter a delayed shutdown mode.
- If the hob is set with a timer, once the countdown reaches "0," the hood will also enter a delayed shutdown mode automatically.

(9) TROUBLE-SHOOTING GUIDE

Trouble	Cause	Remedy	
Burners can not be ignited.	Gas supply is not opened	Turn on the gas	○
	Gas type is bent or crushed.	Straighten or changing the tube	○
	Short of gas supply	Replace it	○
	Air remains in the gas piping	Repeat igniting operation until all air in the piping is purged out.	○
	Electrode not in right position	Adjust it's position	△
	Small spark when ignition operation	Clear the Electrode	○
	Out off battery	Replace or install the battery	○
	Electrode broken	Replace the ignition electrode	△
Flame is extinguished	Thermocouple dirty, broken, or not in right position	Clear or replace it, or adjust it's position	△
	Electromagnet valve broken	Replace it	△
	Valve broken	Replace it	△
	Uneven flame in thermocouple	Adjust the damper	○
Gas leakage (or smell of gas)	Cracks or holes in Gas pipe	Replace it with a new one	△
	The main flame of burners is not ignited	Ignite again after the gas is clear in the air.	○
	Gas valve is not well sealed	Replace gas valve	△
	Sealing packing for gasvalve is broken	Replace the sealing packing.	○
Flame not regular	Burner cap not in proper position	Put it to proper position	○
Weak flame	Gas pressure not enough	Check the gas flow	△
Flame easy to fall	Damper hole is too big	Adapt the damper	○
Long and yellow flame	Damper hole is too small	Adapt the damper	○
Uneven flame	Hole for burner cap is stuff	Clear the hole	○

Remark: Trouble with mark “○” can be solved by final users. Trouble with “△” must be repaired by technical people. If final user can not solve problem according to above guide, call our after-sale service.