



# USER MANUAL



**Livinox Malaysia Sdn Bhd** (1089457-U)  
No 32A, Jalan Teknologi 3/3A,  
Taman Sains Selangor 1, Kota Damansara,  
47810 Petaling Jaya, Selangor.

[www.livinox.my](http://www.livinox.my)



Careline  
+603-6150 7810

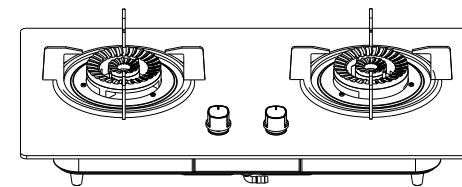

LGH-128 2B-BL

Dear Consumer,  
 Thank you for your purchase of our products. To ensure you use the appliance in the best effect, please read this instruction manual with care before using and save it for future reference.

 **The manufacturer declines all responsibility for damage to persons or things caused by non observance of the above prescriptions or by interference with any part of the appliance or by the use of non original spares**

## CONTENT

SPECIAL PRECAUTIONS .....	1
PARTS IDENTIFICATION .....	3
INSTALLATION .....	4
DIRECTION FOR USE .....	5
PRODUCT DIMENSIONS .....	6
CLEANING AND MAINTENANCE .....	6
TROUBLE-SHOOTING GUIDE .....	7

## (1) SPECIAL PRECAUTIONS

To avoid any danger and loss when using the hob, we make below mark. Below is all about special precautions. Please pay full attention to it and operate in a right way.

■ Marks are identified by different danger and loss level

 **WARNING** If ignoring this mark and operate improperly, it may lead die, hurt or fire.

 **ATTENTION** If ignoring this mark and operate improperly, it may lead die, hurt or fire.

**ADVICE** In order to be safe and convenient when using it, please kindly understand this content.

■ Marks for ATTENTION

					
BURNING	MUST DO	FORBIDDANCE	NO FIRE	NO TOUCH	NO DISASSEMBLY

### DANGER

 When gas leakage  
 1.stop using the hob immediately.  
 2.turn off the gas valve  
 3.open windows and doors  
 4.contact the local gas company



 If case of gas leakage  
 \*do not ignite any fire.  
 \*do not turn on any electrical appliance  
 \*do not touch power plug  
 \*do not use telephone nearby

Flame spark will lead fire.



 When feeling strange burning, or smell gas, or in case of earthquake, fire, please do as below:  
 1.turn the knob to OFF position  
 2.turn off the gas valve  
 3.contact our after-sale service dept. immediately

Above is to avoid fire or fault.

 Please use the right type of gas according to the rating label.

If use the gas other than that are appointed, it may leads gas cooker damage or even fire.

**!** To install, repair, move a gas appliance, must be carried out by our service dept., or a registered gas installer. Otherwise, we will not take the responsibility for any damage.

**!** Any repair, disassembly must be carried out by registered technical people. Or else, it may leads fire or fault.

**!** Must use the specified gas pipe.

**!** Do not put any spray container nearby the hob. It may lead fire.

**!** Any easy-burned item like clothes, newspaper, coal oil, can not be put nearby the hob.

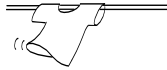

It may lead fire.



**!** Do not use coal oil, gas oil, or other easy-burning and explosive product nearby the hob.

It may lead fire.

### **!** ATTENTION

**!** There should be space of at least 400mm height between the hob bottom and cupboard. And the space can not be sealed, with hole of diameter not less than 0.2 sq meter.

**!** There should be space between hob and items nearby. (not less than 150mm from the wall, 1mm from above)

**!** Gas container can not be put right below the hob. Gas pipe not more than 2 meters.

**!** The hob should be kept more than 1 meter away from the gas container. Gas pipe can not reach other part of the hob.

**!** To ensure the burner and trivet are put in the right place before using the hob.

**!** Keep the kitchen in ventilated situation. But do not let strong wind to below the burner directly.

**!** Do not touch the trivet and burner immediately after using it, because they're very hot.

**!** Turn the knob to OFF and turn off the gas valve after using. Remember to turn off the gas brake when you go out or go to sleep.

### ADVICE

Check whether the gas pipe are in a good situation sometimes. The pipe should be changed for every two years.

## (2) PARTS IDENTIFICATION

### 1.PARTS IDENTIFICATION

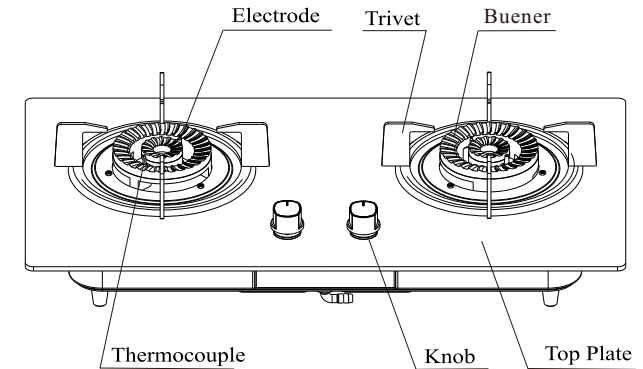

Remark: above is the built-in hob structure and part identification. Other type of hob can refer to above picture.

### (3) INSTALLATION

#### 1. Open holes in the cupboard:

Open holes in the cupboard with the instruction paper in the package.

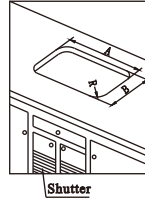

#### 2. Install the gas pipe

A. If to use plastic tube: put in the airproof caution, connect the tube and hob connector, fasten the clip.

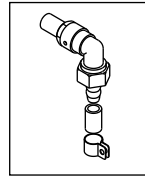

B. If to use metal tube: put in the airproof caution, fasten the nuts on the connection.

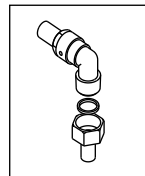

#### 3. Put the hob in the right hole on the cupboard, check whether it's installed in a balance.

The bottom of top plate should be stuck with seal packing.

#### 4. check leakage: turn on the gas valve. check whether with soap water there's leakage in the connection. If any leakage, it needs to be reinstalled.(there'll be air bubble for leakage).

### (4) DIRECTION FOR USE

This ignition safety hob is equipped with a flame failure protection device. If the flame accidentally goes out due to wind or spilled liquids, this device will automatically shut off the gas supply.

1. Insert the battery properly into the battery case located at the bottom of the hob.
2. Turn on the gas valve.
3. While pressing and turning the knob anti-clockwise to the 'Ignite' or 'Full On' position (about 90 degrees), you will hear a series of clicking sounds as the igniter sparks. Once the burner ignites, continue holding the knob in for 2-3 seconds. This allows the safety device (thermocouple) to confirm the flame is lit before you can release it.
4. Turn the knob clockwise to the 'OFF' position. The gas supply will be cut off, and the flame will extinguish.

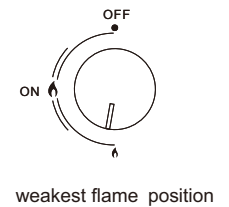
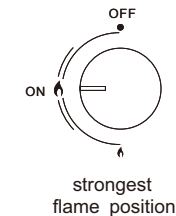
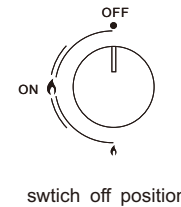

#### NOTE:

1. For the newly installed hob or hob not used for some time, it may fail to ignite at first time, because there's air in the tube. You can repeat until the air is exhausted out, then it can work.
2. If there's yellowish flame or uneven flame, adjust the damper at the bottom to get a normal flame.

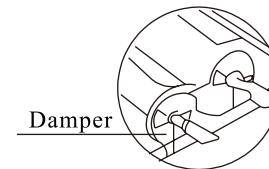

## (5) PRODUCT DIMENSIONS

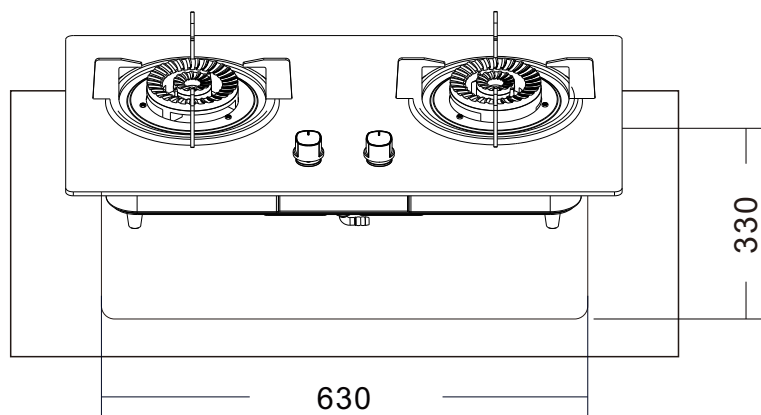

## (6) CLEANING AND MAINTENANCE

To ensure the hob can be used properly, the clearance and maintenance is necessary. Keep the hole of burner cap and gas flow not to be stuff. Keep the electrode and thermocouple clear. Before clearing and maintenance, shut off the gas supply and let all parts cold.

Wash burner caps, burner, electrode, thermocouple and trivets with mild detergent when they're dirty. Then put them back to their proper position. Use steel wire to clear the dirt in the burner cap. When the top plate get dirty, never use any sharp or hard brush but only sponge brush with mild detergent to clean them.

To check the gas tube often, and change new gas tube for every two years.

## (7) TROUBLE-SHOOTING GUIDE

Trouble	Cause	Remedy	
Burners can not be ignited.	Gas supply is not opened	Turn on the gas	○
	Gas type is bent or crushed.	Straighten or changing the tube	○
	Short of gas supply	Replace it	○
	Air remains in the gas piping	Repeat igniting operation until all air in the piping is purged out.	○
	Electrode not in right position	Adjust it's position	△
	Small spark when ignition operation	Clear the Electrode	○
	Out off battery	Replace or install the battery	○
	Electrode broken	Replace the ignition electrode	△
Flame is extinguished	Thermocouple dirty, broken, or not in right position	Clear or replace it, or adjust it's position	△
	Electromagnet valve broken	Replace it	△
	Valve broken	Replace it	△
	Uneven flame in thermocouple	Adjust the damper	○
Gas leakage (or smell of gas)	Cracks or holes in Gas pipe	Replace it with a new one	△
	The main flame of burners is not ignited	Ignite again after the gas is clear in the air.	○
	Gas valve is not well sealed	Replace gas valve	△
	Sealing packing for gasvalve is broken	Replace the sealing packing.	○
Flame not regular	Burner cap not in proper position	Put it to proper position	○
Weak flame	Gas pressure not enough	Check the gas flow	△
Flame easy to fall	Damper hole is too big	Adapt the damper	○
Long and yellow flame	Damper hole is too small	Adapt the damper	○
Uneven flame	Hole for burner cap is stuff	Clear the hole	○

Remark: Trouble with mark “○” can be solved by final users. Trouble with “△” must be repaired by technical people. If final user can not solve problem according to above guide, call our after-sale service.