

# FREE STANDING OVEN

90x60

Gas & Electrical Oven

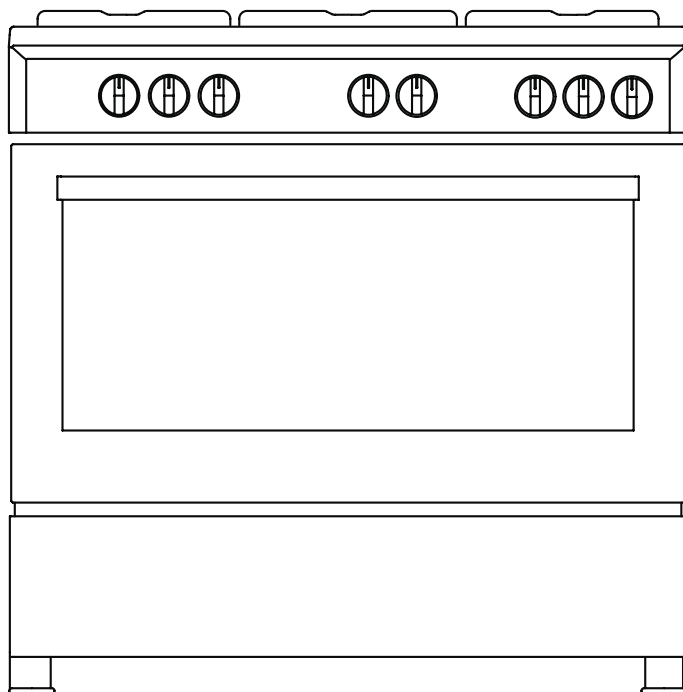

H10-20-180-052 Rev 014

**USER MANUAL** **GB**



**Dear User,**

Our objective is to make this product provide you with the best output which is manufactured in our modern facilities in a careful working environment, in compliance with total quality concept.

Therefore, we suggest you to read the user manual carefully before using the product and, keep it permanently at your disposal.

**Note:** This user manual is prepared for more than one model. Some of the features specified in the Manual may not be available in your appliance.

All our appliances are only for domestic use, not for commercial use.

Products marked with (\*) are optional.

**“THIS APPLIANCE SHALL BE INSTALLED IN ACCORDANCE WITH THE REGULATIONS FORCE AND ONLY USED IN A WELL VENTILATED SPACE. READ THE INSTRUCTIONS BEFORE INSTALLING OR USING THIS APPLIANCE”**

**“Conforms with the WEEE Regulations.”**

## Contents

Important warnings.....	4
Electrical connection.....	16
Gas connection.....	17
Introduction of the appliance.....	22
Accessories.....	23
Technical features of your oven.....	24
Installation of your oven.....	27
Installation of the oven feet.....	29
Chain lashing illustration.....	29
Control panel.....	30
Using oven section.....	31
Using the grill.....	32
Using the chicken roasting.....	32
Using cooker section.....	33
Program types.....	35
Cooking time table.....	36
Maintenance and cleaning.....	37
Installation of the oven door.....	38
Cleaning and maintenance of the oven's front door glass.....	39
Catalytic walls.....	39
Rack positions.....	39
Changing the oven lamp.....	40
Using the grill deflector sheet.....	41
Troubleshooting.....	42
Handling rules.....	44
Recommendations for energy saving.....	44
Environmentally-friendly disposal.....	45
Package information.....	45

## IMPORTANT WARNINGS

1. Installation and repair should always be performed by **“AUTHORIZED SERVICE”**. Manufacturer shall not be held responsible for operations performed by unauthorized persons.
2. Please read this operating instructions carefully. Only by this way you can use the appliance safely and in a correct manner.
3. The oven should be used according to operating instructions.
4. Keep children below the age of 8 and pets away when operating.
5. **WARNING: The accessible parts may be hot while using the grill. Keep away from children.**
6. **WARNING: Fire hazard; do not store the materials on the cooking surface.**
7. **WARNING: The appliance and its accessible parts are hot during operation.**
8. Setting conditions of this device are specified on the label. (Or on the data plate)
9. The accessible parts may be hot when the grill is used. Small children should be kept away.
10. **WARNING: This appliance is intended for cooking. It should not be used for other purposes like heating a room.**
11. To clean the appliance, do not use steam cleaners.
12. Ensure that the oven door is completely closed after putting food inside the oven.



**13.** NEVER try to put out the fire with water. Only shut down the device circuit and then cover the flame with a cover or a fire blanket.

**14.** Children under 8 years of age should be kept away, if they cannot be monitored continuously.

**15.** Touching the heating elements should be avoided.

**16. CAUTION: Cooking process shall be supervised. Cooking process shall always be supervised.**

**17.** This device can be used by children over 8 years of age, people with physical, hearing or mental challenges or people with lack of experience or knowledge; as long as control is ensured or information is provided regarding the dangers.

**18.** This device has been designed for household use only.

**19.** Children must not play with the appliance. Cleaning or user maintenance of the appliance shall not be performed by children unless they are older than 8 years and supervised by adults.

**20.** Keep the appliance and its power cord away from children less than 8 years old.

**21.** Put curtains, tulle, paper or any flammable (ignitable) material away from the appliance before starting to use the appliance. Do not put ignitable or flammable materials on or in the appliance.

**22.** Keep the ventilation channels open.

**23.** The appliance is not suitable for use with an external timer or a separate remote control system.

**24.** Do not heat closed cans and glass jars. The pressure may lead jars to explode.

**25.** Oven handle is not a towel drier. Do not hang towels, etc. on the oven handle.

**26.** Do not place the oven trays, plates or aluminium foils directly on the oven base. The accumulated heat may damage the base of the oven.

**27.** While placing food to or removing food from the oven, etc., always use heat resistant oven gloves.

**28.** Do not use the product in states like medicated and/or under influence of alcohol which may affect your ability of judgement.

**29.** Be careful when using alcohol in your foods. Alcohol will evaporate at high temperatures and may catch fire to cause a fire if it comes in contact with hot surfaces.

**30.** After each use, check if the unit is turned off.

**31.** If the appliance is faulty or has a visible damage, do not operate the appliance.

**32.** Do not touch the plug with wet hands. Do not pull the cord to plug off, always hold the plug.

**33.** Do not use the appliance with its front door glass removed or broken.

**34.** Place the baking paper together with the food into a pre-heated oven by putting it inside a cooker or on an oven accessory (tray, wire grill etc.).



**35.** Do not put objects that children may reach on the appliance.

**36.** It is important to place the wire grill and tray properly on the wire racks and/or correctly place the tray on the rack. Place the grill or tray between two rails and make sure it is balanced before putting food on it.

**37.** Against the risk of touching the oven heater elements, remove excess parts of the baking paper that hang over from the accessory or container.

**38.** Never use it at higher oven temperatures than the maximum usage temperature indicated on your baking paper. Do not place the baking paper on the base of the oven.

**39.** When the door is open, do not place any heavy object on the door or allow children to sit on it. You may cause the oven to overturn or the door hinges to be damaged.

**40.** The packaging materials are dangerous for children. Keep packaging materials away from the reach of children.

**41.** Do not use abrasive cleaners or sharp metal scrapers to clean the glass as the scratches that may occur on the surface of the door glass may cause the glass to break.

**42.** Do not place the appliance on a surface covered with carpets. Electric parts gets overheated since there will be no ventilation from below. This will cause failure of the appliance.

**43.** Do not hit glass surfaces of vitro-ceramic cookers with a hard metal, resistance can get damaged. It may cause an electric shock.

**44.** User should not handle the oven by himself.

**45.** Use shall be careful when cleaning gas burners. It may cause personal injuries.

**46.** Food can spill when foot of oven is dismantled or gets broken, be careful. It may cause personal injuries.

**47.** During usage, the internal and external surfaces of the oven get hot. As you open the oven door, step back to avoid the hot vapour coming out from the interior. There is risk of burning.

**48.** Upper cover of the oven can be closed for a reason, than cookware can trip over. Step back to avoid the hot food coming on you. There is risk of burning.

**49.** Do not place heavy objects when oven door is open, risk of toppling.

**50.** User should not dislocate the resistance during cleaning. It may cause an electric shock.

**51.** Do not remove ignition switches from the appliance. Otherwise, live electric cables can be accessed. It may cause an electric shock.

**52.** Oven supply can be disconnected during any construction work at home. After completing the work, re-connecting the oven shall be done by authorized service.

**53.** Do not place metal utensils such as knife, fork, spoon on the surface of the appliance, since they will get hot.



**54.** To prevent overheating, the appliance should not be installed behind of a decorative cover.

**55.** Turn off the appliance before removing the safeguards. After cleaning, install the safeguards according to instructions.

**56.** Cable fixing point shall be protected.

**57. WARNING: Don't use oven and grill burners at same time.**

**58.** Please don't cook the food directly on the tray / grid. Please put the food into or on appropriate tools before putting them in the oven.

**59.** Hot surface, leave for cooling before closing the cover.



## Electrical Safety

1. Plug the appliance in a grounded socket protected by a fuse conforming to the values specified in the technical specifications chart.

2. Have an authorized electrician set grounding equipment. Our company shall not be responsible for the damages that shall be incurred due to using the product without grounding according to local regulations.

3. The circuit breaker switches of the oven shall be placed so that end user can reach them when the oven is installed.

4. The power supply cord (the cord with plug) shall not contact the hot parts of the appliance.

5. If the power supply cord (the cord with plug) is damaged, this cord shall be replaced by the manufacturer or its service agent or an equally qualified personnel to prevent a hazardous situation.

6. Never wash the product by spraying or pouring water on it! There is a risk of electrocution.

7. **WARNING: To avoid electric shock, ensure that the device circuit is open before changing the lamp.**

8. **WARNING: Cut off all supply circuit connections before accessing the terminals.**

9. **WARNING: If the surface is cracked, turn off the appliance to avoid risk of electric shock.**

10. Do not use cut or damaged cords or extension cords other than the original cord.

**11.** Make sure that there is no liquid or humidity in the outlet where the product plug is installed.

**12.** The rear surface of the oven also heats up when the oven is operated. Electrical connections shall not touch the rear surface, otherwise the connections may be damaged.

**13.** Do not tighten the connecting cables to the oven door and do not run them over hot surfaces. If the cord melts, this may cause the oven to short circuit and even a fire.

**14.** Unplug the unit during installation, maintenance, cleaning and repair.

**15.** If the power supply cable is damaged, it must be replaced by its manufacturer or authorized technical service or any other personnel qualified at the same level, in order to avoid any dangerous situation.

**16.** Make sure the plug is inserted firmly into wall socket to avoid sparks.

**17.** Do not use steam cleaners for cleaning the appliance, otherwise electric shock may occur.

**18.** An omnipolar switch capable to disconnect power supply is required for installation. Disconnection from power supply shall be provided with a switch or an integrated fuse installed on fixed power supply according to building code.

**19.** Appliance is equipped with a **type “Y”** cord cable.

**20.** Fixed connections shall be connected to a power supply enabling omnipolar disconnection. For appliances with over voltage category below III, disconnection device shall be connected to fixed power supply according to wiring code.

## **Gas Safety**

**1.** This appliance is not connected to burning products evacuation apparatus. This appliance must be connected and installed according to the installation regulations in force. Conditions regarding ventilation must be considered.

**2.** When a gas cooking appliance is used; humidity, heat and burning products are generated in the room. First of all, make sure the kitchen is well ventilated when operating the appliance and maintain natural ventilation openings or install a mechanical ventilation equipment.

**3.** After using the appliance heavily for an extended period of time, additional ventilation may be required. For example open a window or adjust a higher speed for mechanical ventilation, if any.

**4.** This appliance must be used only in well ventilated locations in accordance with the regulations in force. Please read the manual before installing or using this product.

**5.** Before positioning the appliance, make sure local network conditions (gas type and gas pressure) meets appliance requirements.



**6.** The mechanism cannot be run for longer than 15 seconds. If the burner is not on after 15 seconds, stop the mechanism and wait for at least one minute before trying to ignite the burner again.

**7.** All kinds of operations to be performed on gas installation must be performed by authorized and competent people.

**8.** This appliance is adjusted for natural gas (NG). If you have to use your product with a different gas type, you have to apply to authorized service for the conversion.

**9.** For proper operation, hood, gas pipe and clamp should be replaced periodically according to manufacturer recommendations and when required.

**10.** Gas should burn well in gas products. Well burning gas can be understood from blue flame and continuous burning. If gas does not burn sufficiently, carbon monoxide (CO) can be generated. Carbon monoxide is a colourless, odourless and very toxic gas; even small amounts have lethal effect.

**11.** Ask your local gas supplies about the phone numbers for emergencies related to gas and the measures to be taken upon gas odour is detected.



## **What To Do When Gas Odour Is Detected**

- 1.** Do not use naked flame, and do not smoke.
- 2.** Do not operate any electrical switch.  
(For example: lamp switch or doorbell)
- 3.** Do not use telephone or mobile phone.
- 4.** Open the doors and windows.
- 5.** Close all valves on the appliances that utilize gas and the gas counters.
- 6.** Call fire brigade from a telephone outside the home.
- 7.** Check all hoses and their connections against leaks.  
If you still smell gas, leave the house and warn your neighbours.
- 8.** Do not enter into the house until authorities clarify it is safe.



## **Intended Use**

**1.** This product is designed for home use. Commercial use of the appliance is not permitted.

**2.** This appliance may only be used for cooking purposes. It shall not be used for other purposes like heating a room.

**3.** This appliance shall not be used to heat plates under the grill, drying clothes or towels by hanging them on the handle or for heating purposes.

**4.** The manufacturer assumes no responsibility for any damage due to misuse or mishandling.

**5.** Oven part of the unit may be used for thawing, roasting, frying and grilling food.

**6.** Operational life of the product you have purchased is 10 years. This is the period for which the spare parts required for the operation of this product as defined is provided by the manufacturer.

## Electrical Connection

1. Your oven requires 16 or 32 Ampere fuse according to the appliance's power. If necessary, installation by a qualified electrician is recommended.

2. Your oven is adjusted in compliance with 220-240V AC/380-415V AC 50/60Hz electric supply. If the mains are different from this specified value, contact your authorized service.

3. Electrical connection of the oven should only be made by the sockets with earth system installed in compliance with the regulations. If there is no proper socket with earth system in the place where the oven will be placed, immediately contact a qualified electrician. Manufacturer shall never be responsible from the damages that will arise because of the sockets connected to the appliance with no earth system. If the ends of the electrical connection cable are open, according to the appliance type, make a proper switch installed in the mains by which all ends can be disconnected in case of connecting / disconnecting from / to the mains.

4. If your electric supply cable gets defective, it should definitely be replaced by the authorized service or qualified electricians in order to avoid from the dangers.

5. Electrical cable should not touch the hot parts of the appliance.

6. Please operate your oven in dry atmosphere.

### Electrical connection scheme

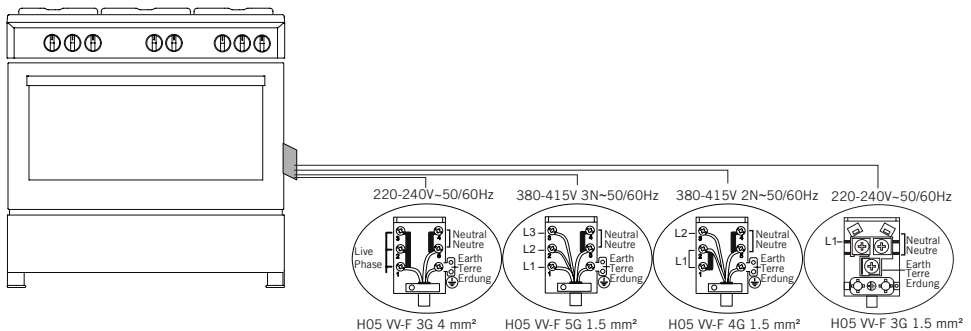

## Gas Connection

**WARNING:** Before starting any work related with gas installation, turn off gas supply. Risk of explosion.

Please operate your oven in dry atmosphere.

1. Fit the clamp to the hose. Push one of the hose until it goes to the end of the pipe.

2. For the sealing control; ensure that the buttons in the control panel are closed, but the gas cylinder is open. Apply some soap bubbles to the connection. If there is gas leakage, there will be foaming in the soaped area.

3. The oven should be using a well ventilation place and should be install on flat ground.

4. Re-inspect the gas connection.

5. When placing your oven to its location, ensure that it is at the counter level. Bring it to the counter level by adjusting the feet if necessary.

6. Do not make gas hose and electrical cable of your oven go through the heated areas, especially through the rear side of the oven. Do not move gas connected oven. Since the forcing shall loosen the hose, gas leakage may occur.

7. Please use flexible hose for gas connection.

### For LPG connection;

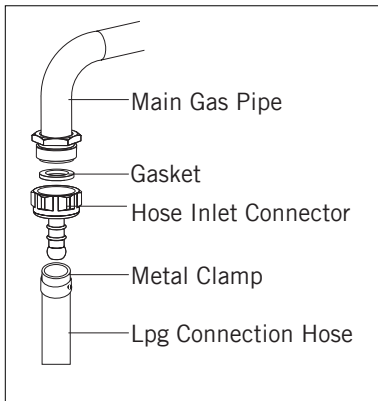

1. For LPG (cylinder) connection, affix metal clamp on the hose coming from LPG cylinder. Affix an edge of the hose on hose inlet connector behind the appliance by pushing to end through heating the hose in boiled water. Afterward, bring the clamp towards end section of the hose and tighten it with screwdriver. The gasket and hose inlet connector required for connection is as the picture shown below.

**NOTE:** The regulator to be affixed on LPG cylinder should have 300 mmSS feature.

## For natural gas connection;

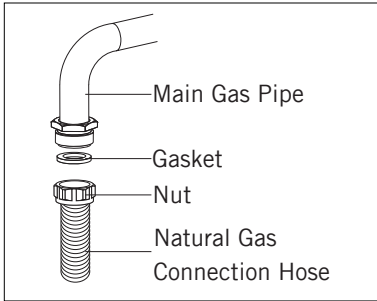

**WARNING:** Natural gas connection should be done by authorized service.

For natural gas connection, place gasket in the nut at the edge of natural gas connection hose. To install the hose on main gas pipe, turn the nut. Complete the connection by making gas leakage control.

## Gas hose passage way

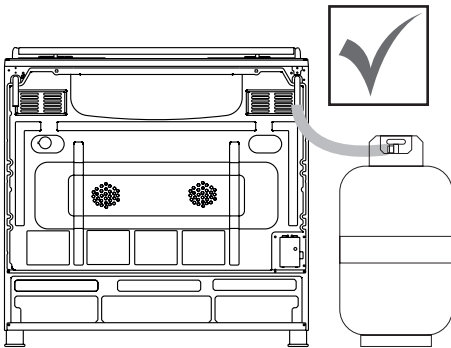

Figure 1

Connect the appliance to the gas piping tap in shortest possible route and in a way that ensure no gas leakage will occur.

In order to carry on a tightness and sealing safety check ensure that the knobs on the control panel are closed and the gas cylinder is open.

**WARNING:** While performing a gas leakage check, never use any kind of lighter, match, cigarette or similar burning substance.

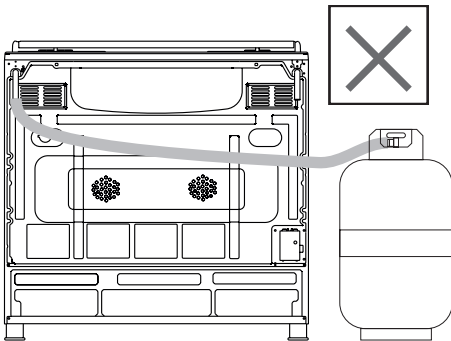

Figure 2

Apply soap bubble on the connection points. If there is any kind of leakage then it will cause bubbling.

While inserting the appliance in place ensure that it is on the same level with the worktop. If required adjust the legs in order to make level with the worktop.

Use the appliance on a level surface and in a well ventilated environment.

**WARNING:** Before placing the appliance, check that the local distribution conditions (gas type and pressure) conform to the product settings.

## Nozzle change operation

1. Please use driver with special head for removed and install nozzle as. (figure 3)

2. Please remove nozzle (figure 4) from burner with special nozzle driver and install new nozzle. (figure 5)

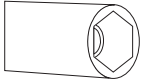

Figure 3

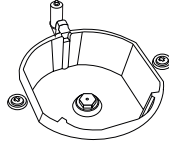

Figure 4

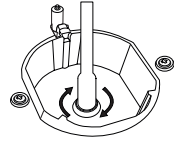

Figure 5

## Ventilation of room

The air needed for burning is received from room air and the gases emitted are given directly in room. For safe operation of your product, good room ventilation is a precondition. If no window or room to be utilized for room ventilation is available, additional ventilation should be installed. However, room has a door opening outside, it is no needed to vent holes.

Room size	Ventilating opening
Smaller than 5 m <sup>3</sup>	min. 100 cm <sup>2</sup>
Between 5 m <sup>3</sup> - 10 m <sup>3</sup>	min. 50 cm <sup>2</sup>
Bigger than 10 m <sup>3</sup>	no need
In basement or cellar	min. 65 cm <sup>2</sup>

## Reduced gas flow rate setting for hob taps

1. Ignite the burner that is to be adjustment and turn the knob to the reduced position.

2. Remove the knob from the gas tap.

3. Use an appropriately sized screwdriver to adjust the flow rate adjustment screw. For LPG (butane-pro pane) turn the screw clockwise. For the naturel gas, you should turn the screw counter- clockwise once.

“The normal length of a straight flame in the reduced position should be 6-7 mm.”

4. If the flame is higher then the desired position, turn the screw clockwise. If it is smaller turn anticlockwise.

5. For the last control, bring the burner both to higt-flame and reduced positions and check whether the flame is on or off.

Depending on the type of gas tap used in your appliance the adjustment screw position may vary.

To adjust your oven acc. to the gas type, make the adjustment for reduced flame carefully by turning with a small screwdriver as shown below on the screw in the middle of the gas cocks as well as nozzle changes (figure 6 and 7).

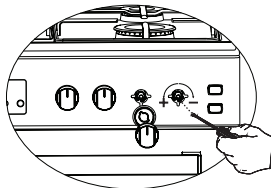

Figure 6

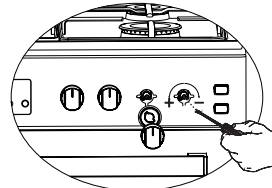

Figure 7

## Removal of the lower and upper burner and installation of the injector to the gas oven

### Removal of the upper burner:

With the help of a screw driver, remove the screw as shown in figure 8. As shown in figure 8.1, remove the injector in the bearing with a socket wrench. In order to re-place the burner, apply the removal process reversely.

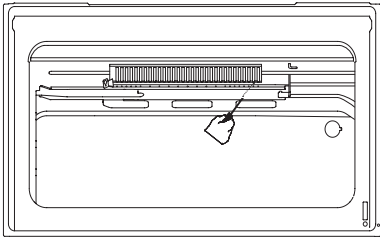

Figure 8

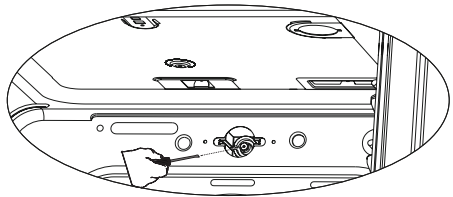

Figure 8.1

### Removal of the lower burner:

The lower burner door has been fixed with two screws. As shown in figure 9, remove it with the help of a screw driver. As shown in figure 9.1, remove the injector in the bearing with a socket wrench. In order to re-place the burner, apply the removal process reversely.

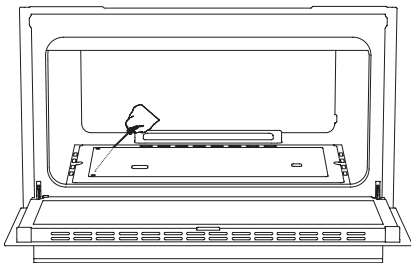

Figure 9

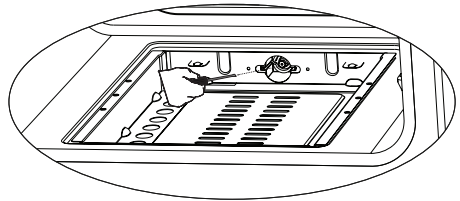
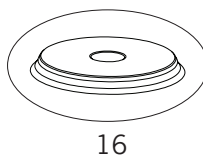
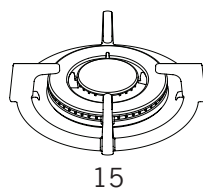
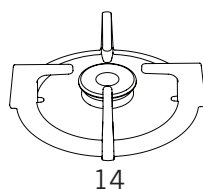
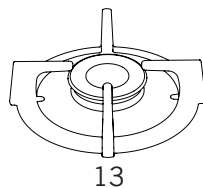
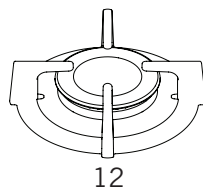
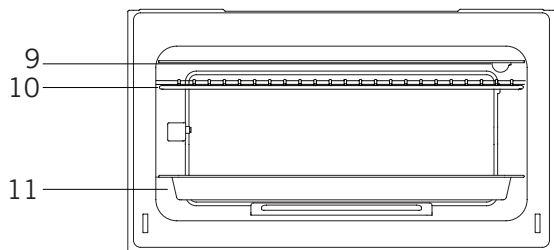
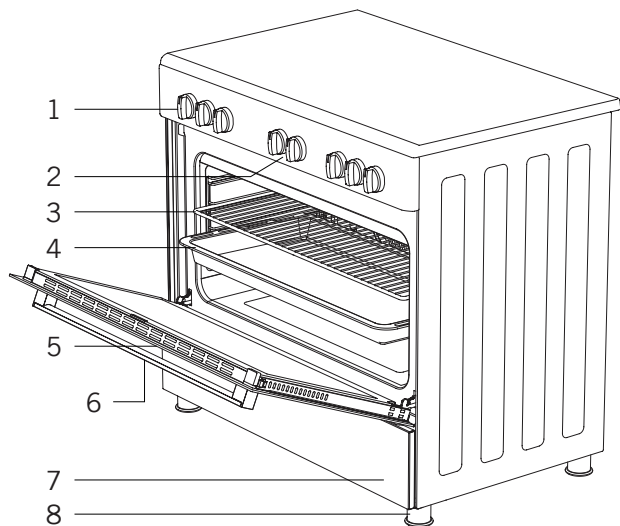

Figure 9.1

## INTRODUCTION OF THE APPLIANCE



1. Oven control knobs
2. Hob control knobs
3. Wire grill
4. Deep tray
5. Door
6. Handle
7. Lower cabinet door
8. Plastic leg

9. Lamp
10. Grill
11. Deep tray
12. Large burner
13. Middle burner
14. Auxiliary burner
15. Wok burner \*
16. Hot plate \*

## Accessories

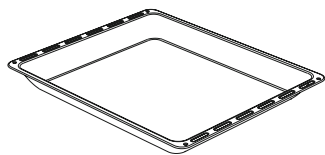

### Deep tray

Used for pastries, deep fried foods and stew recipes. In case of frying directly on the grill for cakes, frozen foods and meat dishes, it can be used of oil pick-up tray.

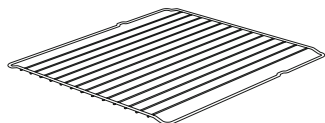

### Wire grill

Used for frying and/or placing the foods to be baked, fried and frozen foods on the desired rack.

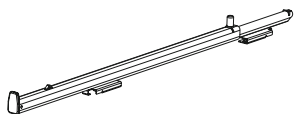

### Telescopic rail \*

With the help of telescopic rails, the trays and/or wire racks can be easily placed and removed.

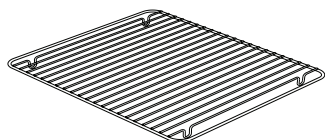

### In tray wire grill \*

Foods that can stick while cooking such as beef are placed on in tray grill. Thus, the contact and sticking of the food is prevented.

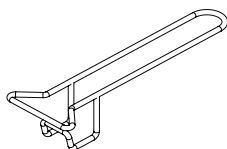

### Tray handle \*

It is used to hold hot trays.



### Splash back \*

The resulting temperature of the oven chimney avoid contact with the wall.

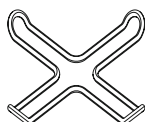

### Coffee pot support unit \*

Can be used for coffee pot.

## Technical Features Of Your Oven

Specifications	90x60
Outer width	900 mm
Outer depth	610 mm
Outer height	925 mm
Lamp power	15-25 W
Bottom heating element	2000 W
Top heating element	1500 W
Grill heating element	** 2500 W / 3250 W
Turbo heating element	2200 W x 1 / 1250 W x 2 / 1800 W x 2
Supply voltage	220-240 V AC / 380-415 V AC 50/60 Hz
Hot plate 145 mm *	1000 W
Hot plate 180 mm *	1500 W
Hot plate rapid 145 mm *	1500 W
Hot plate rapid 180 mm *	2000 W

\*\* only for mix product.

**WARNING:** For the modification to be done by authorized service, this table should be considered. Manufacturer may not be held responsible for any problems rising because of any faulty modification.

**WARNING:** In order to increase the product quality, the technical specifications may be changed without prior notice.

**WARNING:** The values provided with the appliance or its accompanying documents are laboratory readings in accordance with the respective standards. These values may differ depending on the use and ambient conditions.

Burner Specifications	G20,20 mbar G25,25 mbar			G20,25 mbar		G20,13 mbar		G20,10 mbar	
	Gas natural			Gas natural		Gas natural		Gas natural	
Wok Burner (3,5)	Injector	1,40	mm	1,28	mm	1,60	mm	1,60	mm
	Gas flow	0,333	m <sup>3</sup> /h	0,333	m <sup>3</sup> /h	0,333	m <sup>3</sup> /h	0,318	m <sup>3</sup> /h
	Power	3,50	kW	3,50	kW	3,50	kW	3,33	kW
Wok Burner (4,5)	Injector	1,60	mm	1,35	mm	1,84	mm	---	mm
	Gas flow	0,468	m <sup>3</sup> /h	0,468	m <sup>3</sup> /h	0,468	m <sup>3</sup> /h	---	m <sup>3</sup> /h
	Power	4,50	kW	4,50	kW	4,50	kW	---	kW
Fish Burner	Injector	1,18	mm	1,10	mm	1,35	mm	---	mm
	Gas flow	0,301	m <sup>3</sup> /h	0,301	m <sup>3</sup> /h	0,301	m <sup>3</sup> /h	---	m <sup>3</sup> /h
	Power	2,90	kW	2,90	kW	2,90	kW	---	kW
Rapid Burner	Injector	1,15	mm	1,10	mm	1,45	mm	1,55	mm
	Gas flow	0,276	m <sup>3</sup> /h	0,276	m <sup>3</sup> /h	0,276	m <sup>3</sup> /h	0,318	m <sup>3</sup> /h
	Power	2,90	kW	2,90	kW	2,90	kW	3,00	kW
Semi-Rapid Burner	Injector	0,97	mm	0,92	mm	1,10	mm	1,20	mm
	Gas flow	0,162	m <sup>3</sup> /h	0,162	m <sup>3</sup> /h	0,162	m <sup>3</sup> /h	0,185	m <sup>3</sup> /h
	Power	1,70	kW	1,70	kW	1,70	kW	1,95	kW
Auxiliary Burner	Injector	0,72	mm	0,70	mm	0,85	mm	0,90	mm
	Gas flow	0,96	m <sup>3</sup> /h	0,96	m <sup>3</sup> /h	0,96	m <sup>3</sup> /h	0,100	m <sup>3</sup> /h
	Power	0,95	kW	0,95	kW	0,95	kW	1,00	kW
Grill Burner	Injector	1,10	mm	1,03	mm	1,15	mm	---	mm
	Gas flow	0,238	m <sup>3</sup> /h	0,238	m <sup>3</sup> /h	0,238	m <sup>3</sup> /h	---	m <sup>3</sup> /h
	Power	2,50	kW	2,50	kW	2,50	kW	---	kW
Oven Burner	Injector	1,30	mm	1,15	mm	1,55	mm	---	mm
	Gas flow	0,333	m <sup>3</sup> /h	0,333	m <sup>3</sup> /h	0,333	m <sup>3</sup> /h	---	m <sup>3</sup> /h
	Power	3,50	kW	3,50	kW	3,50	kW	---	kW
Grill Burner	Injector	1,20	mm	1,20	mm	---	---	---	---
	Gas flow	0,257	m <sup>3</sup> /h	0,257	m <sup>3</sup> /h	---	---	---	---
	Power	2,70	kW	2,70	kW	---	---	---	---
Oven Burner	Injector	1,45	mm	1,45	mm	---	---	---	---
	Gas flow	0,381	m <sup>3</sup> /h	0,381	m <sup>3</sup> /h	---	---	---	---
	Power	4,00	kW	4,00	kW	---	---	---	---

Burner Specifications	G30,28-30 mbar G31,37 mbar			G30,50 mbar		G30,37 mbar		G30,27.5 mbar	
	LPG			LPG		LPG		LPG	
Wok Burner (3,5)	Injector	0,96	mm	0,76	mm	0,96	mm	0,92	mm
	Gas flow	254	g/h	254	g/h	254	g/h	242	g/h
	Power	3,50	kW	3,50	kW	3,50	kW	3,33	kW
Wok Burner (4,5)	Injector	1,07	mm	0,92	mm	1,00	mm	---	mm
	Gas flow	327	g/h	327	g/h	327	g/h	---	g/h
	Power	4,50	kW	4,50	kW	4,50	kW	---	kW
Fish Burner	Injector	0,85	mm	0,70	mm	0,80	mm	---	mm
	Gas flow	211	g/h	211	g/h	211	g/h	---	g/h
	Power	2,90	kW	2,90	kW	2,90	kW	---	kW
Rapid Burner	Injector	0,85	mm	0,75	mm	0,85	mm	0,90	mm
	Gas flow	211	g/h	211	g/h	211	g/h	221,7	g/h
	Power	2,90	kW	2,90	kW	2,90	kW	3,00	kW
Semi-Rapid Burner	Injector	0,65	mm	0,60	mm	0,65	mm	0,70	mm
	Gas flow	124	g/h	124	g/h	124	g/h	141	g/h
	Power	1,70	kW	1,70	kW	1,70	kW	1,95	kW
Auxiliary Burner	Injector	0,50	mm	0,43	mm	0,50	mm	0,50	mm
	Gas flow	69	g/h	69,1	g/h	69,1	g/h	76,3	g/h
	Power	0,95	kW	0,95	kW	0,95	kW	1,00	kW
Grill Burner	Injector	0,78	mm	0,70	mm	0,75	mm	---	mm
	Gas flow	182	g/h	182	g/h	182	g/h	---	g/h
	Power	2,50	kW	2,50	kW	2,50	kW	---	kW
Oven Burner	Injector	0,92	mm	0,82	mm	0,87	mm	---	mm
	Gas flow	254	g/h	254	g/h	254	g/h	---	g/h
	Power	3,50	kW	3,50	kW	3,50	kW	---	kW
Grill Burner	Injector	0,85	mm	---	---	---	---	---	---
	Gas flow	196	g/h	---	---	---	---	---	---
	Power	2,70	kW	---	---	---	---	---	---
Oven Burner	Injector	1,00	mm	---	---	---	---	---	---
	Gas flow	291	g/h	---	---	---	---	---	---
	Power	4,00	kW	---	---	---	---	---	---

**WARNING:** Diameter values written on the injector are specified without a comma. For example; The diameter of 1,70 mm is specified as 170 on the injector.

## INSTALLATION OF YOUR OVEN

Check if the electrical installation is proper to bring the appliance in operating condition. If electricity installation is not suitable, call an electrician and plumber to arrange the utilities as necessary. Manufacturer shall not be held responsible for damages caused by operations performed by unauthorized persons.

**WARNING:** It is customer's responsibility to prepare the location the product shall be placed on and also to have the electrical installation prepared.

**WARNING:** The rules in local standards about electrical installations shall be followed during product installation.

**WARNING:** Check for any damage on the appliance before installing it. Do not have the product installed if it is damaged. Damaged products cause a risk for your safety.

### Right Place for Installation and Important Warnings

Appliance feet should not stay on soft surfaces such as carpets. The kitchen floor shall be durable to carry the unit weight and any other kitchenware that may be used on the oven.

The appliance is suitable for use on both side walls, without any support, or without being installed in a cabinet. If a hood or aspirator will be installed above the cooker, follow the instructions of the manufacturer for height of mounting. (min. 650 mm)

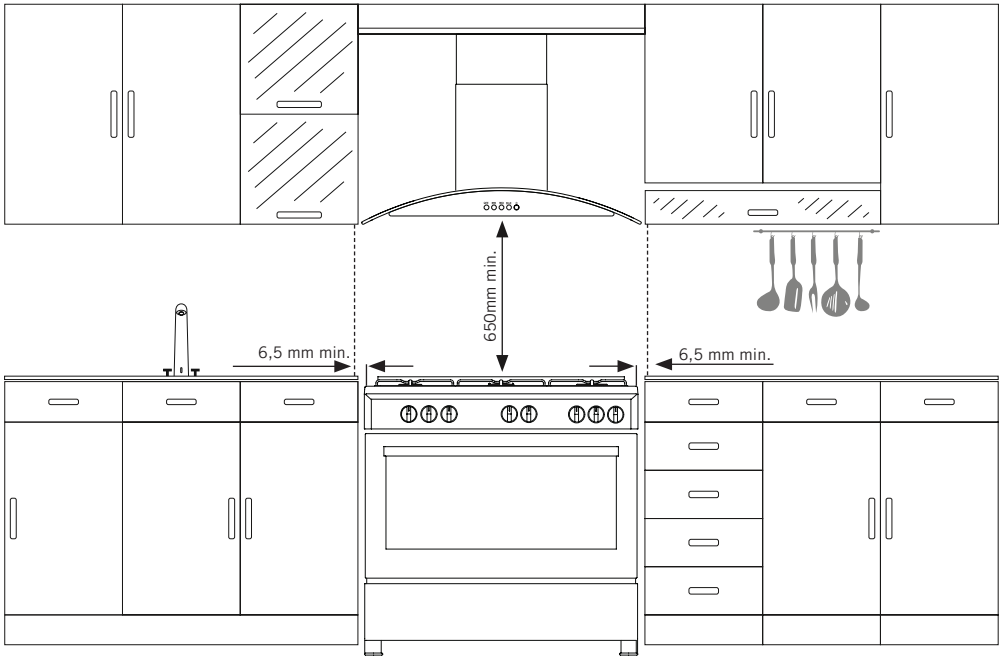

**WARNING:** The kitchen furniture near the appliance must be heat resistant.

**WARNING:** Do not use the door and/or handle to carry or move the appliance.

**WARNING:** Do not install the appliance beside refrigerators or coolers. Heat radiated by the appliance increases the energy consumption of cooling devices.

## Installation Of The Oven Feet

### In order to install the oven feet;

1. Foot attachment lath is installed on the oven from the bottom of the oven as shown in (figure 10). Nuts are centered on these lathes in order to screw feet. Complete the feet installation process by screwing the feet to the nuts (figure 11).

2. You can balance your oven by turning the screwed feet according to the surface type you are using.

3. If your oven has plastic food as in (figure 12) you can adjust your ovens height from these feet as turned clockwise or anticlockwise.

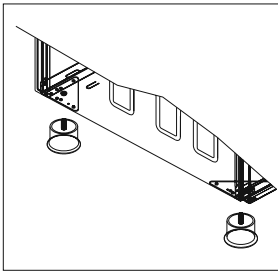

Figure 10

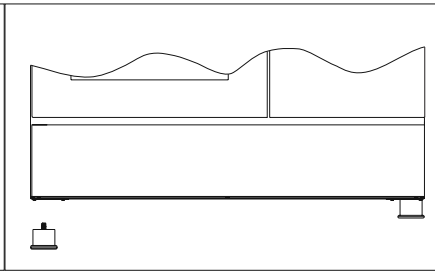

Figure 11

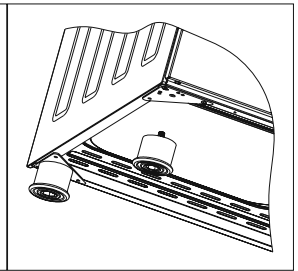
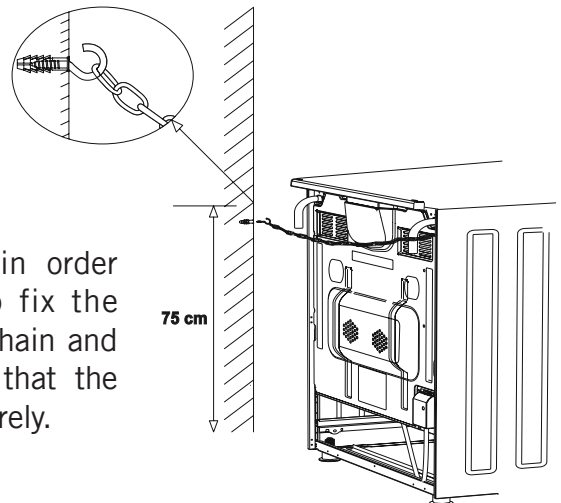

Figure 12

## Chain Lashing Illustration

Before using the appliance, in order to ensure safe use, be sure to fix the appliance to the wall using the chain and hooked screw supplied. Ensure that the hook is screwed into the wall securely.



## CONTROL PANELS

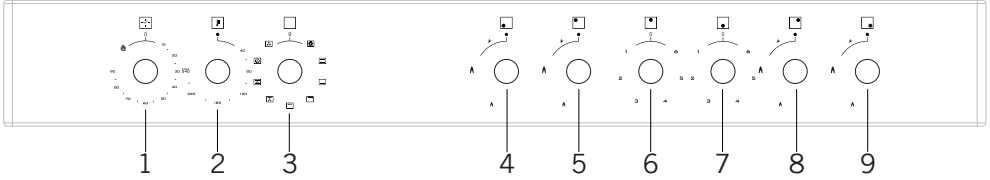

- |                              |                                |
|------------------------------|--------------------------------|
| 1. Mechanical timer          | 6. Rear center electric heater |
| 2. Thermostat                | 7. Rear center electric heater |
| 3. Function selection button | 8. Rear right heater           |
| 4. Front left heater         | 9. Front right heater          |
| 5. Rear left heater          |                                |

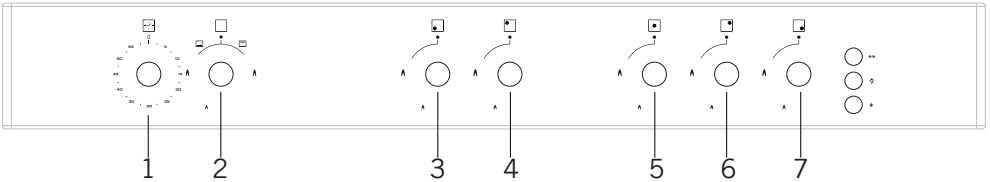

- |                              |  |
|------------------------------|--|
| 1. Mechanical timer          | 5. Center heater<br>(Wok burner or hotplate) |
| 2. Function selection button | 6. Rear right heater                         |
| 3. Front left heater         | 7. Front right heater                        |
| 4. Rear left heater          |  |

**WARNING:** The control panel above is only for illustration purposes. Consider the control panel on your device.

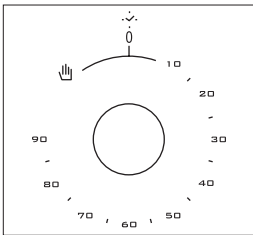

**Mechanical timer\*:** Used for determining the period for cooking in the oven. When adjusted time is expired, power to heaters is turned off and an audible warnig signal is emitted. Mechanical timer can be adjusted to desired period between 0-90 minutes. For cooking periods, see cooking tables.

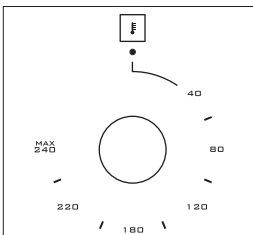

**Thermostat:** Used for determining the cooking temperature of the dish to be cooked in the oven. After placing the food inside the oven, turn the switch to adjust desired temperature setting between 40-240 °C. For cooking temperatures of different food, see cooking table.

## **USING OVEN SECTION**

### **Using Oven Burners**

1. If your oven equipped with burners that operates with gas, appropriate knob should be used in order to ignite the burners. Some models have automatic ignition from the knob; it is easy to ignite the burner by turning the knob. Also, burners can be ignited by pressing the ignition button or they can be ignited with a match.

2. Do not continuously operate the igniter for more than 15 seconds. If the burner does not ignite, wait minimum one minute before trying again. If the burner is extinguished for of the any reason, close the gas control valve and wait a minimum of one minute before trying again.

### **Using Oven Heating Elements**

1. When your oven is operated first time, an odor will be spread out which will be sourced from using the heating elements. In order to get rid of this, operate it at 240 °C for 45-60 minutes while it is empty.

2. Oven control knob should be positioned to desired value; otherwise oven does not operate.

3. Kinds of meals, cooking times and thermostat positions are given in cooking table. The values given in the cooking table are characteristic values and were obtained as a result of the tests performed in our laboratory. You can find different flavors suitable for your taste depending on your cooking and using habits.

4. You can make chicken revolving in your oven by means of the accessories.

5. Cooking times: The results may change according to the area voltage and material having different quality, amount and temperatures.

6. During the time when cooking is being performed in the oven, the lid of the oven should not be opened frequently. Otherwise circulation of the heat may be imbalanced and the results may change.

## Using The Grill

1. When you place the grill on the top rack, the food on the grill shall not touch the grill.
2. You can preheat for 5 minutes while grilling. If necessary, you may turn the food upside down.
3. Food shall be in the center of the grill to provide maximum air flow through the oven.

### To turn on the grill;

1. Place the function button over the grill symbol.
2. Then, set it to the desired grill temperature.

### To turn the grill off;

Set the function button to the off position.

**WARNING:** Keep the oven door closed while grilling. (electrical grill)

**WARNING:** Keep the oven door opened while grilling. (gas grill)

## Using The Chicken Roasting \*

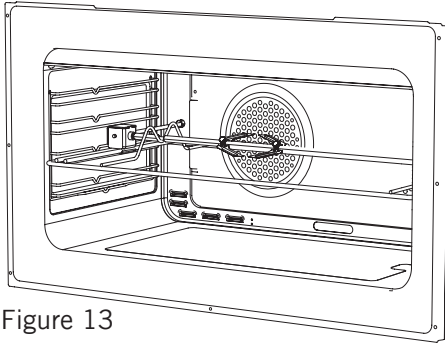
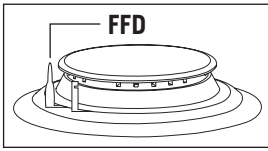

Figure 13

Place the spit on the frame. Slide turn spit frame into the oven at the desired level. Locate a dripping pan through the bottom in order to collect the fat. Add some water in dripping pan for easy cleaning. Do not forget to remove plastic part from spit. After grilling, screw the plastic handle to the skewer and take out the food from oven.

## Using Cooker Section

### Using Gas Burners



**Flame cut-off safety device (FFD) \***; operates instantly when safety mechanism activates due to overflowed liquid over upper hobs.

1. The valves controlling the gas cookers have special security mechanism. In order to light the cooker always press on the switch forward and bring it to flame symbol by turning counterclockwise. All of the lighters shall operate and the cooker you controlled shall light only. Keep the switch pressed until ignition is performed. Press on the lighter button and turn the knob counter clockwise.

2. Do not continuously operate the igniter for more than 15 seconds. If the burner does not ignite, wait minimum one minute before trying again.

3. In models with gas security system, when flame of the cooker is extinguished, control valve cuts off the gas automatically. For operating the burners with gas security system you must press the knob and turn counter-clockwise. After the ignition you must wait nearly 5-10 seconds for gas security systems activation. If the burner is extinguished for any reason, close the gas control valve and wait a minimum of one minute before trying again.

4. ● Closed 🔥 Fully open 🔥 Half open

5. Before operating your hob please make sure that the burner caps are well positioned. The right placement of the burner caps are shown as below.

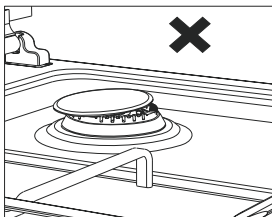

Figure 14

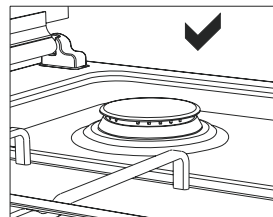

Figure 15

## Using Hot Plates

	Level 1	Level 2	Level 3	Level 4	Level 5	Level 6
Ø80 mm	200 W	250 W	450 W	---	---	---
Ø145 mm	250 W	750 W	1000 W	---	---	---
Ø180 mm	500 W	750 W	1500 W	---	---	---
Ø145 mm rapid	500 W	1000 W	1500 W	---	---	---
Ø180 mm rapid	850 W	1150 W	2000 W	---	---	---
Ø145 mm	95 W	155 W	250 W	400 W	750 W	1000 W
Ø180 mm	115 W	175 W	250 W	600 W	850 W	1500 W
Ø145 mm rapid	135 W	165 W	250 W	500 W	750 W	1500 W
Ø180 mm rapid	175 W	220 W	300 W	850 W	1150 W	2000 W
Ø220 mm	220 W	350 W	560 W	910 W	1460 W	2000 W

1. Electric hotplates have standard of 6 temperature levels. (as describe herein above)

2. When using first time, operate your electric hotplate in position 6 for 5 minutes. This will make the agent on your hotplate which is sensitive to heat get hardened by burning.

3. Use flat bottomed saucepans which fully contact with the heat as much as you can, so that you can use the energy more productively.

### Pot Sizes







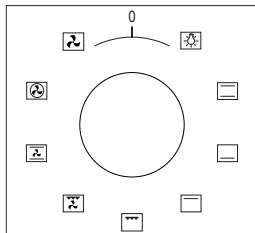











90*60	
Small burner	12-18 cm
Normal burner	18-22 cm
Big burner	22-26 cm
WOK burner	26-32 cm



## PROGRAM TYPES



**Function Button:** Used for determining the heaters to be used for cooking the dish to be cooked in the oven. Heater program types in this button and their functions are described below. All heater types and program types consisting of these heaters may not be available at all models.

	Roast chicken		Fan
	Lower and upper heating elements		Turbo heating and fan
	Lamp		Lower-upper heating element and fan
	Lower heating element and fan		Grill and fan
	Grill and roast chicken		Grill
	Grill and lamp		Upper heating element
	Electrical timer		Lower heating element
	Flame		Ignition lighter
	Small grill and fan		Small grill
	Multifunctional cooking (3D)		

**WARNING:** All heater types and program types consisting of these heaters may not be available at all models.

## COOKING TIME TABLE

**WARNING:** Oven must be preheated for 7-10 minutes before placing the food in it.

Food	Cooking function	Cooking temperature (°C)	Cooking rack	Cooking time (min.)
Cake	Static	180	2	70
Small cake	Static	180	2	40
Pie	Static	200	2	70
Pastry	Static+Fan	180-200	2	20-25
Cookie	Static	175	2	20
Apple pie	Static	180-190	1	150
Sponge cake	Static	175	2	45-50
Pizza	Static	190	2	25
Lasagne	Static	180-200	2	50-60
Meringue	Static	100	2	60
Grilled chicken *	Grill+Fan	220	4	25-35
Grilled fish *	Grill+Fan	220	4	35-40
Calf steak *	Grill	Max.	4	30
Grilled meatball *	Grill	Max.	4	40

\* Food must be turned after half of the cooking time.

## MAINTENANCE AND CLEANING

1. Disconnect the plug supplying electricity for the oven from the socket.
2. While oven is operating or shortly after it starts operating, it is extremely hot. You must avoid touching from heating elements.
3. Never clean the interior part, panel, lid, trays and all other parts of the oven by the tools like hard brush, cleaning mesh or knife. Do not use abrasive, scratching agents and detergents.
4. After cleaning the interior parts of the oven with a soapy cloth, rinse it and then dry thoroughly with a soft cloth.
5. Clean the glass surfaces with special glass cleaning agents.
6. Do not clean your oven with steam cleaners.
7. Before opening the upper lid of the oven, clean spilled liquid off the lid. Also, before closing the lid, ensure that the cooker table is cooled enough.
8. Never use inflammable agents like acid, thinner and gasoline when cleaning your oven.
9. Do not wash any part of your oven in dishwasher.
10. In order to clean the front glass lid of the oven; remove the fixing screws fixing the handle by means of a screwdriver and remove the oven door. Then clean and rinse it thoroughly. After drying, place the oven glass properly and re-install the handle.

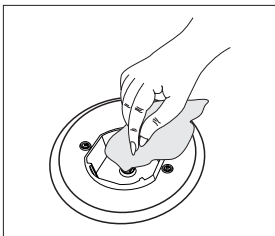

Figure 16

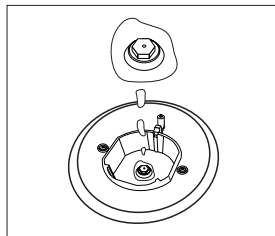

Figure 17

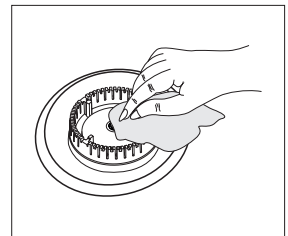

Figure 18

## Installation Of The Oven Door

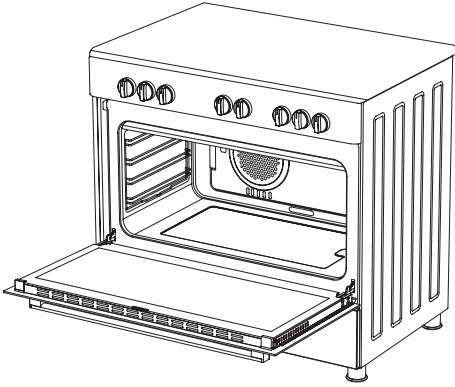

Figure 19

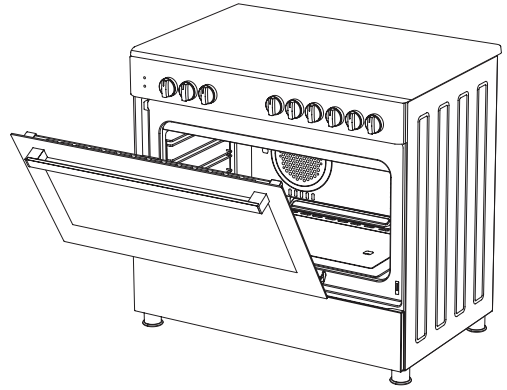

Figure 20

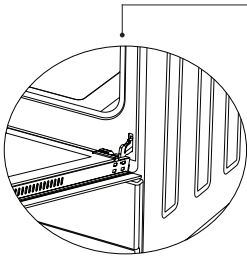

Figure 19.1

Completely open the oven door by pulling it to yourself. Afterwards, perform the unlocking process by pulling the hinge lock upwards with the help of a screw driver as shown in **figure 19.1**.

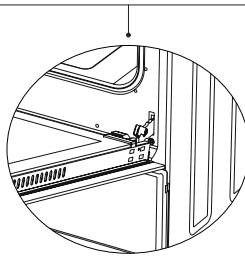

Figure 19.2

Bring the hinge lock to the widest angle as shown in **figure 19.2**. Bring both hinges connecting the oven door to the oven to the same position.

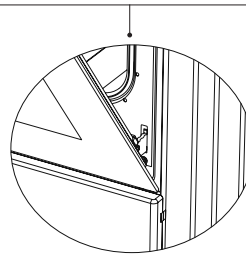

Figure 20.1

Afterwards, close the oven door as to lean on the hinge lock as shown in **figure 20.1**.

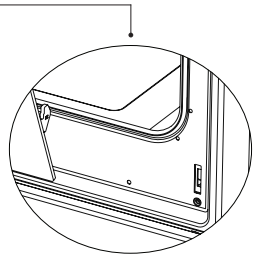

Figure 20.2

To remove the oven door, pull it upwards by holding it with both hands when close to the closed position as shown in **figure 20.2**.

In order to re-place the oven door, perform the abovementioned steps in reverse.

## Cleaning And Maintenance Of The Oven's Front Door Glass

Remove the profile by pressing the plastic latches on both left and right sides as shown in figure 21 and pulling the profile towards yourself as shown in figure 22. Then remove the inner-glass as shown in figure 23. If required, middle glass can be removed in the same way. After cleaning and maintenance are done, remount the glasses and the profile in reverse order. Make sure the profile is properly seated in its place.

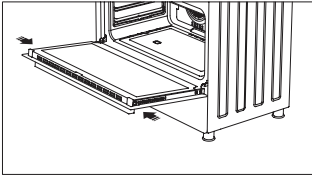

Figure 21

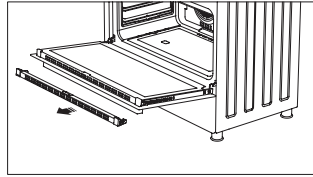

Figure 22

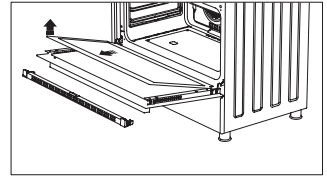

Figure 23

## Catalytic Walls \*

Catalytic walls are located on the left and the right side of cavity under the guides. Catalytic walls banish the bad smell and obtain the best performance from the cooker. Catalytic walls also absorb oil residue and clean your oven while it's operating.

### Removing the catalytic walls

In order to remove the catalytic walls; the guides must be pulled out. As soon as the guides are pulled out, the catalytic walls will be released automatically. The catalytic walls must be changed after 2-3 years.

## Rack Positions \*

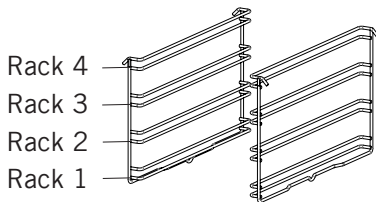

It is important to place the wire grill into the oven properly. Do not allow wire rack to touch rear wall of the oven. Rack positions are shown in the next figure. You may place a deep tray or a standard tray in the lower and upper wire racks.

### Installing and removing wire racks

To remove wire racks, press the clips shown with arrows in the figure, first remove the lower, and than the upper side from installation location. To install wire racks; reverse the procedure for removing wire rack.

## Changing The Oven Lamp

**WARNING:** To avoid electric shock, ensure that the appliance circuit is open before changing the lamp. (having circuit open means power is off) First disconnect the power of appliance and ensure that appliance is cold.

Remove the glass protection by turning as indicated in the figure on the left side. If you have difficulty in turning, then using plastic gloves will help you in turning.

Then remove the lamp by turning, install the new lamp with same specifications.

Reinstall glass protection, plug the power cable of appliance into electrical socket and complete replacement. Now you can use your oven.

### Type G9 Lamp

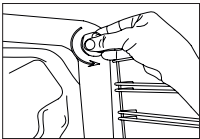

220-240 V, AC  
15-25 W

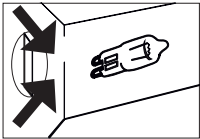
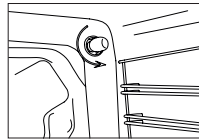

Figure 24

### Type E14 Lamp



220-240 V, AC  
15 W

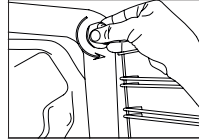

Figure 25

**WARNING:** This product contains a light source of energy efficiency class G.

## Using The Grill Deflector Sheet \*

1. A safety panel is designed to protect control panel and the buttons when the oven is in grill mode. (figure 26)

2. Please use this safety panel in order to avoid the heat to damage control panel and the buttons when the oven is grill mode.

**WARNING:** Accessible parts may be hot when the grill in use. Young children should be kept away.

3. Place the safety panel under control panel by opening the oven front cover glass. (figure 27)

4. And then secure the safety panel in between oven and front cover by gently closing the cover. (figure 28)

5. It is important for cooking to keep the cover open in specified distance when cooking in grill mode.

6. Safety panel will provide an ideal cooking circumstance while protecting control panel and buttons.

**WARNING:** If the cooker has the “**closed grill functioned**” option with thermostat, you can keep the oven door closed during operation; in this case the grill deflector sheet will be unnecessary.

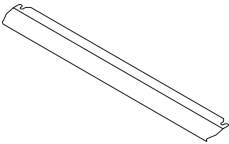

Figure 26

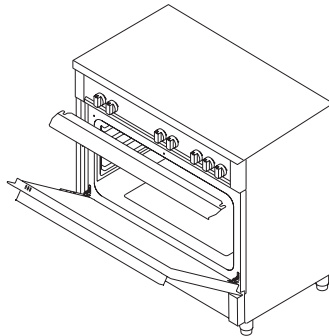

Figure 27

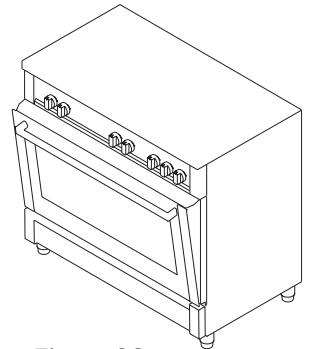

Figure 28

## TROUBLESHOOTING

You may solve the problems you may encounter with your product by checking the following points before calling the technical service.

### Check Points

In case you experience a problem about the oven, first check the table below and try out the suggestions.

Problem	Possible Cause	What to Do
<b>Oven does not operate.</b>	Power supply not available.	Check for power supply.
	Gas supply not available.	Check if main gas valve is open.
		Check if gas pipe is bent or kinked.
		Make sure gas hose is connected to the oven.
		Check if suitable gas valve is being used.
<b>Oven stops during cooking.</b>	Plug comes out from the wall socket.	Re-install the plug into wall socket.
<b>Turns off during cooking.</b>	Too long continuous operation.	Let the oven cool down after long cooking cycles.
	More than one plugs in a wall socket.	Use only one plug for each wall socket.
<b>Oven door is not opening properly.</b>	Food residues jammed between the door and internal cavity.	Clean the oven well and try to re-open the door.
<b>Lighter not operating.</b>	Tips or body of ignition plugs are clogged.	Clean tips or body of ignition plugs of gas burners.
	Gas burner pipes are clogged.	Clean gas burner pipes.
<b>Electric shock when touching the oven.</b>	No proper grounding.	Make sure power supply is grounded properly.
	Ungrounded wall socket is used.	

<b>Problem</b>	<b>Possible Cause</b>	<b>What to Do</b>
<b>Water dripping.</b>	Water or steam may generate under certain conditions depending on the food being cooked. This is not a fault of the appliance.	Let the oven cool down and than wipe dry with a dishcloth.
<b>Steam coming out from a crack on oven door.</b>		
<b>Water remaining inside the oven.</b>		
<b>Oven does not heat.</b>	Oven door is open.	Close the door and restart.
	Oven controls not correctly adjusted.	Read the section regarding operation of the oven and reset the oven.
	Fuse tripped or circuit breaker turned off.	Replace the fuse or reset the circuit breaker. If this is repeating frequently, call an electrician.
<b>Smoke coming out during operation.</b>	When operating the oven for the first time.	Smoke comes out from the heaters. This is not a fault. After 2-3 cycles, there will be no more smoke.
	Food on heater.	Let the oven to cool down and clean food residues from the heater.
<b>When operating the oven burnt or plastic odour coming out.</b>	Plastic or other not heat resistant accessories are being used inside the oven.	At high temperatures, use suitable glassware accessories.
<b>Oven does not cook well.</b>	Oven door is opened frequently during cooking.	Do not open oven door frequently, if the food you are cooking does not require turning. If you open the door frequently internal temperature drops and therefore cooking result will be influenced.
<b>Internal light is dim or does not operate.</b>	Foreign object covering the lamp during cooking.	Clean internal surface of the oven and check again.
	Lamp might be failed.	Replace with a lamp with same specifications.



## **HANDLING RULES**

1. Do not use the door and/or handle to carry or move the appliance.
2. Carry out the movement and transportation in the original packaging.
3. Pay maximum attention to the appliance while loading/unloading and handling.
4. Make sure that the packaging is securely closed during handling and transportation.
5. Protect from external factors (such as humidity, water, etc.) that may damage the packaging.
6. Be careful not to damage the appliance due to bumps, crashes, drops, etc. while handling and transporting and not to break or deform it during operation.

## **RECOMMENDATIONS FOR ENERGY SAVING**

Following details will help you use your product ecologically and economically.

1. Use dark coloured and enamel containers that conduct the heat better in the oven.
2. As you cook your food, if the recipe or the user manual indicates that pre-heating is required, pre-heat the oven.
3. Do not open the oven door frequently while cooking.
4. Try not to cook multiple dishes simultaneously in the oven. You may cook at the same time by placing two cookers on the wire rack.
5. Cook multiple dishes successively. The oven will not lose heat.
6. Turn off the oven a few minutes before the expiration time of cooking. In this case, do not open the oven door.
7. Defrost the frozen food before cooking.

## ENVIRONMENTALLY-FRIENDLY DISPOSAL

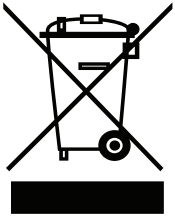

Dispose of packaging in an environmentally-friendly manner.

This appliance is labelled in accordance with European Directive 2012/19/EU concerning used electrical and electronic appliances (waste electrical and electronic equipment - WEEE). The guideline determines the framework for the return and recycling of used appliances as applicable throughout to the EU.

## PACKAGE INFORMATION

Packaging materials of the product are manufactured from recyclable materials in accordance with our National Environment Regulations. Do not dispose of the packaging materials together with the domestic or other wastes. Take them to the packaging material collection points designated by the local authorities.