

LIVINOX

Built-In Electric Hob Manual

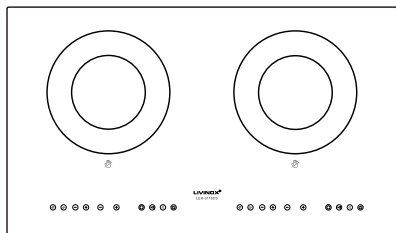

LEH-3118CS

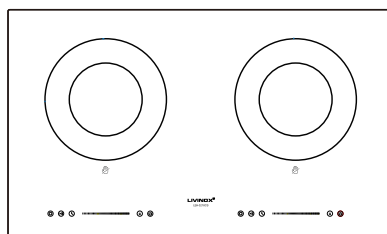

LEH-3218CS

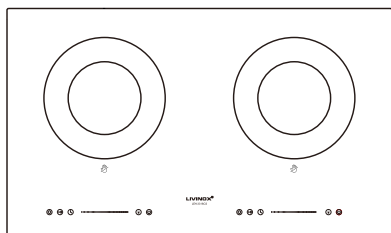

LEH-3318CS

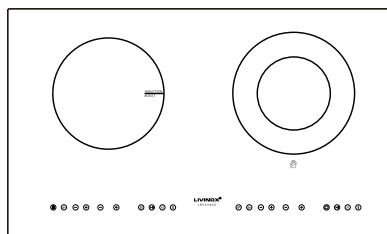

LEH-4118ICS
LEH-5118ICS

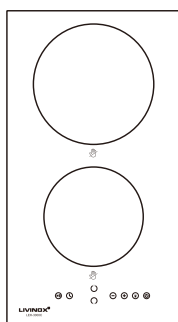

LEH-3000C

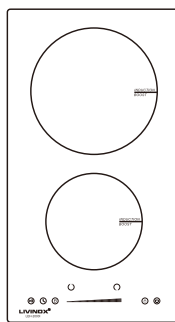

LEH-2000I

CONTENTS:

Part 1. Safety Warnings

Part 2. Installation

Part 3. Operation Instructions

Part 4. Cleaning and Maintenance

Congratulations on the purchase of your new hob and thank you for choosing us!

Please read all the safety instructions carefully before use and keep this Manual for future reference.

Part 1. Safety Warnings

Safety Warnings

Your safety is important to us. Please read below information carefully before installing or using your Hob.

Installation

Electrical Shock Hazard

- Disconnect the appliance from the mains electricity supply before carrying out any work or maintenance on it.
- Connection to a good earth wiring system is essential and mandatory.
- Alterations to the domestic wiring system must only be made by a qualified electrician.
- Failure to follow this advice may result in electrical shock or death.

Cut Hazard

- Be cautious - panel edges are sharp.

- Failure to use caution could result in injury or cuts.

Important safety instructions

- Read these instructions carefully before installing or using this appliance.
- No combustible material or products should be placed on this appliance at any time.
- Please make this information available to the person responsible for installing the hob as it could reduce your installation costs.
- In order to avoid a hazard, this appliance must be installed according to these instructions for installation.
- This appliance is to be properly installed and earthed only by a suitably qualified person.
- This appliance should be connected to a circuit which incorporates an isolating switch providing full disconnection from the power supply.
- Failure to install the appliance correctly could invalidate any warranty or liability claims.

Operation and maintenance

Electrical Shock Hazard

- Do not cook on a broken or cracked hob. If the hob surface should break or crack, switch the appliance off immediately at the mains power supply (wall switch) and contact a qualified technician.
- Switch the hob off at the wall before cleaning or maintenance.
- Failure to follow this advice may result in electrical shock or death.

Health Hazard

- This appliance complies with electromagnetic safety standards.
- However, persons with cardiac pacemakers or other electrical implants (such as insulin pumps) must consult with their doctor or implant manufacturer before using this appliance to make sure that their implants will not be affected by the electromagnetic field.
- Failure to follow this advice may result in death.

Hot Surface Hazard

- During use, accessible parts of this appliance will become hot enough to cause burns.
- Do not let your body, clothing or any item other than suitable cookware contact the ceramic glass until the surface is cool.
- Beware: Metallic objects such as knives, forks, spoons and lids should not be placed on the hob surface since they can get hot.
- Keep children away.
- Handles of saucepans may be hot to touch. Check saucepan handles do not overhang other cooking zones that are on. Keep handles out of reach of children.
- Failure to follow this advice could result in burns and scalds.

Cut Hazard

- The razor-sharp blade of a hob scraper is exposed when the safety cover is retracted. Use with extreme care and always store safely and out of reach of children.
- Failure to use caution could result in injury or cuts.

Important safety instructions

- Never leave the appliance unattended when in use. Boil over causes smoking and greasy spillovers that may ignite.
- Never use your appliance as a work or storage surface.
- Never leave any objects or utensils on the appliance.
- Do not place or leave any magnetisable objects (e.g. credit cards, memory cards) or electronic devices (e.g. computers, MP3 players) near the appliance, as they may be affected by its electromagnetic field.
- Never use your appliance for warming or heating the room.
- After use, always turn off the cooking zones and the hob as described in this manual. Do not rely on the pan detection feature to turn off the cooking zones when you remove the pans.
- Do not allow children to play with the appliance or sit, stand, or climb on it.
- Do not store items of interest to children in cabinets above the hob. Children climbing on the hob could be seriously injured.

- Do not leave children alone or unattended in the area where the appliance is in use.
- Children or persons with a disability which limits their ability to use the appliance should have a responsible and competent person to instruct them in its use. The instructor should be satisfied that they can use the appliance without danger to themselves or their surroundings.
- Do not repair or replace any part of the appliance unless specifically recommended in the manual. All other servicing should be done by a qualified technician.
- Do not use steam cleaner to clean hob.
- Do not place or drop heavy objects on hob.
- Do not stand on your hob.
- Do not use pans with jagged edges or drag pans across the ceramic glass surface as this can scratch the glass.
- Do not use scourers or any other harsh abrasive cleaning agents to clean your hob, as these can scratch the ceramic glass.
- If the power supply cable is damaged, it must only be replaced by qualified technician.

- This appliance is intended to be used in household and similar applications such as: -staff kitchen areas in shops, offices and other working environments; -farm houses; -by clients in hotels, motels and other residential type environments; -bed and breakfast type environments.
- This appliance can be used by children aged from 8 years and above and persons with reduced physical, sensory or mental capabilities or lack of experience and knowledge if they have been given supervision or instruction concerning use of the appliance in a safe way and understand the hazards involved. Children shall not play with the appliance. Cleaning and user maintenance shall not be made by children without supervision.
- **WARNING:** Unattended cooking on a hob with fat or oil can be dangerous and may result in fire. NEVER try to extinguish a fire with water, but switch off the appliance and then cover flame e.g. with a lid or a fire blanket.

Part 2. Installation

Installation Instructions

The appliance must be installed and connected in accordance with current regulations.

After unpacking the appliance, ensure there is no visible damage. If it has been damaged during transit, **DO NOT USE**, contact where you buy immediately.

Selection of installation equipment

- Cut out the work surface according to the sizes shown in the drawing.
- For the purpose of installation and use, a minimum of 5 cm space shall be preserved around the hole.
- Be sure the thickness of the work surface is at least 30mm. Please select heat-resistant work surface material to avoid larger deformation caused by the heat radiation from the hotplate. As shown below:

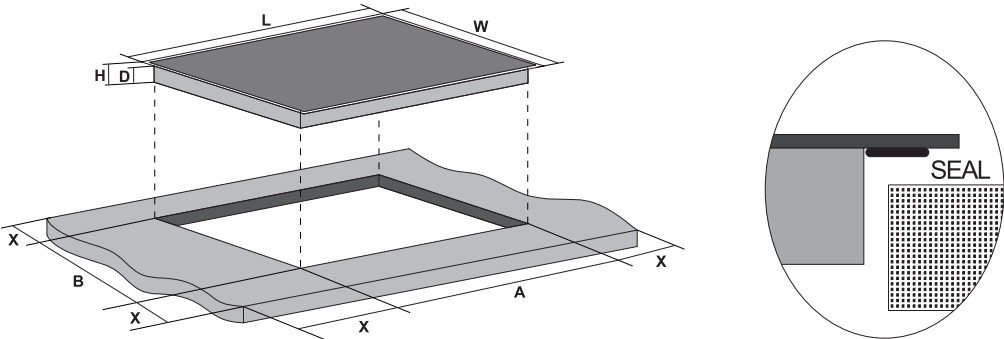

Model	L(mm)	W(mm)	H(mm)	D(mm)	A(mm)	B(mm)	X(mm)
LEH-3000C	288	520	52	48	270	500	50 min
LEH-2000I	288	520	56	52	270	500	50 min
LEH-3118CS LEH-4118ICS LEH-5118ICS LEH-3318CS, LEH-3218CS,	730	430	58	54	665	395	50 min

Under any circumstances, make sure the electric hob is well ventilated and the air inlet and outlet are not blocked. Ensure the electric hob is in good work state. As shown below:



Note: The safety distance between the hotplate and the cupboard above the hotplate should be at least 760mm.

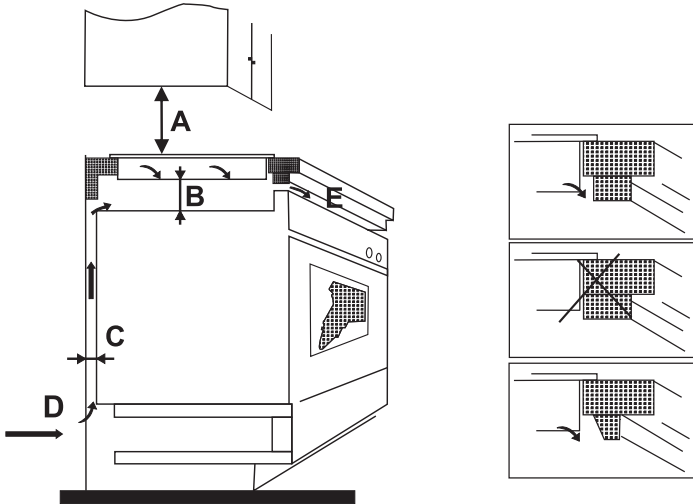

A(mm)	B(mm)	C(mm)	D	E
760mm	50mm minimal	20mm minimal	Air intake	Air exit 5mm

Before locating the fixing brackets(For LEH-2000I and LEH-3000C)

The unit should be placed on a stable, smooth surface (use the packaging). Do not apply force onto the controls protruding from the hob.

Easy Fit kits

There is one easy fit kits package for each hob, include fixing clips and screws (total 2pcs clips and 2pcs screws). Find the easy fit kit package first.

Fix clips to hob: Insert the fixing clips into fixing holes reserved on 2 sides of housing, fix clip to housing with screw, then insert hob into cabinet/work surface.

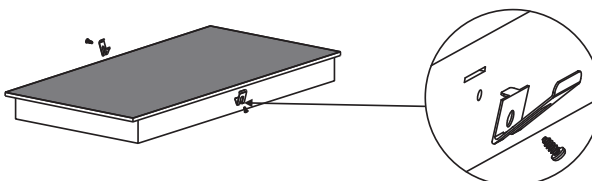

Fix hob to cabinet: Insert the hob into the cabinet/work surface as below diagrams, the mounted clips on the sides can secure your hob sturdily.

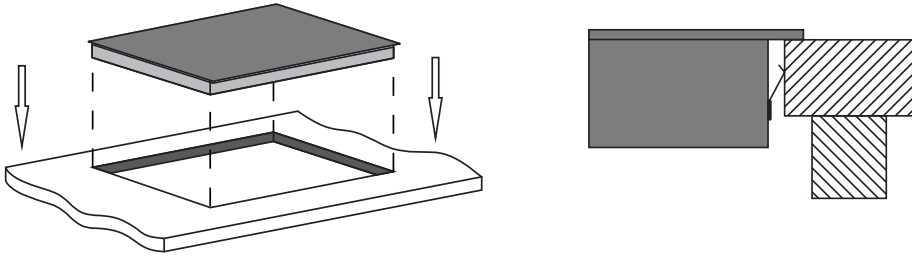

Locating the flexible cut fixing brackets (For LEH-3118CS, LEH-3218CS, LEH-3318CS, LEH-4118ICS and LEH-5118ICS)

These brackets(4pcs) are packed in a bag placed in the side of the protective foam, as shown in the picture below:

Check carefully before throw away the packaging.

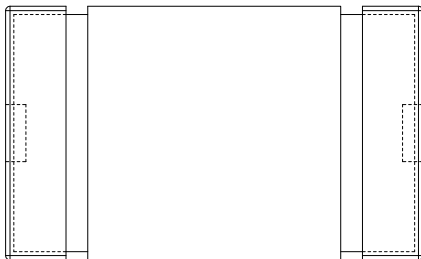
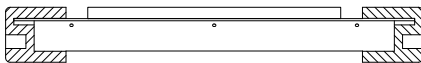

Find the fixing brackets here

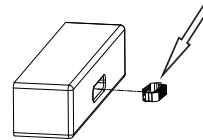

- Fix the hob on the work surface by screw four brackets on the bottom of hob (see picture) after installation.
- Adjust the bracket position to suit for different work surface's thickness.

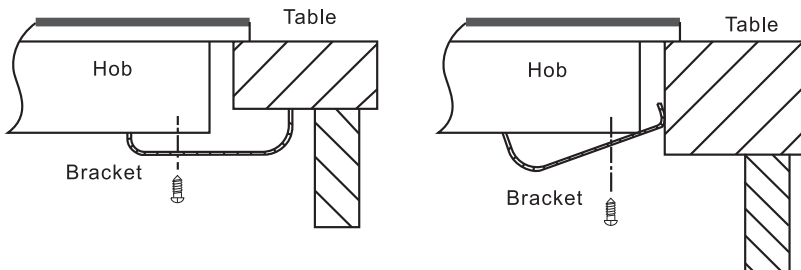

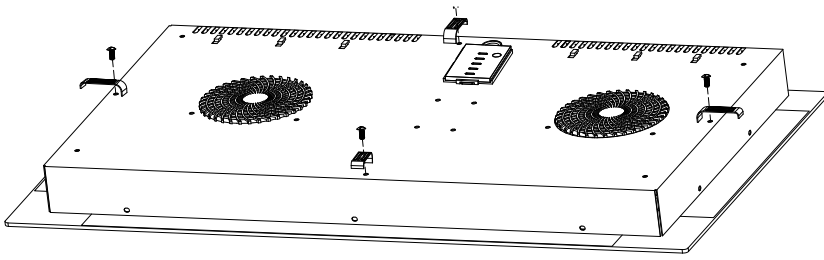

The unit should be placed on a stable, smooth surface (use the packaging). Do not apply force onto the controls protruding from the hob.

Assemble the Rubber Feet

Your hobs have rubber feet. There are 4pcs feet and 4pcs screw in one set packed as accessories. Please assemble the feet to the hob by yourselves if needed. Find the 4pcs feet first, then screw up the feet into the 4 holes reserved in the 4 corners of base.

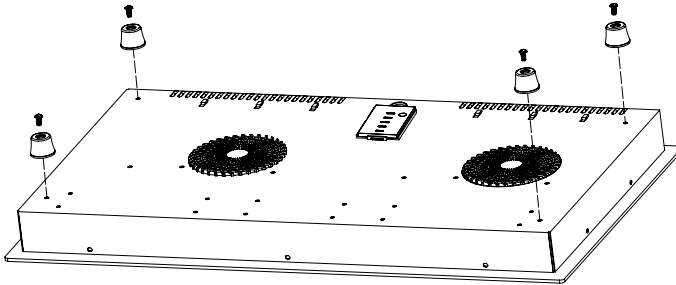

Connecting the hob to the mains power supply

The power supply should be connected in compliance with the relevant standard, or a single-pole circuit breaker. **The appliance have a large power rating and must be connected to electricity by a Qualified Electrician.**

Notes:

1. If the cable is damaged or needs replacing, this should be done by an after-sales technician using the proper tools, so as to avoid any accidents.
2. If the appliance is being connected directly to the mains supply, an omni polar circuit breaker must be installed with a minimum gap of 3mm between the contacts.
3. The installer must ensure that the correct electrical connection has been made and that it complies with safety regulations.
4. The cable must not be bent or compressed.
5. The cable must be checked regularly and only replaced by qualified technician.

The method of connections shown below.

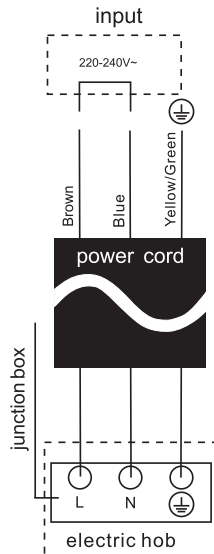

Cautions

1. The hob must be installed by qualified personnel or technicians.

Please never conduct the operation by yourself.

2. The electric hob shall not be mounted to cooling equipment, dishwashers and rotary dryers.
3. The electric hob shall be installed such that better heat radiation can be ensured to enhance its reliability.
4. The wall and induced heating zone above the work surface shall withstand heat.
5. To avoid any damage, the sandwich layer and adhesive must be heat resistant.
6. A steam cleaner is not to be used.

Note: For some of the models, there might applied with a power cord with plug. If so, you can directly plug in socket. Please keep power cord plug out after use, for those model power cord with plug.

Part 3. Operation Instructions

Product Overview

(1) Model: LEH-3000C

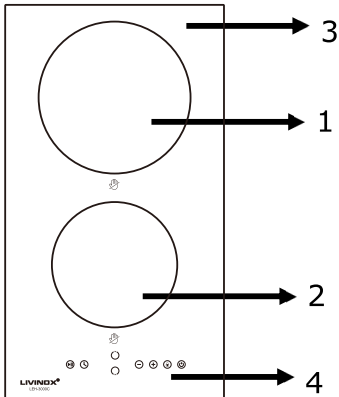

1. 1800W Cooking Zone
2. 1200W Cooking Zone
3. Glass panel
4. Control panel

Control Panel

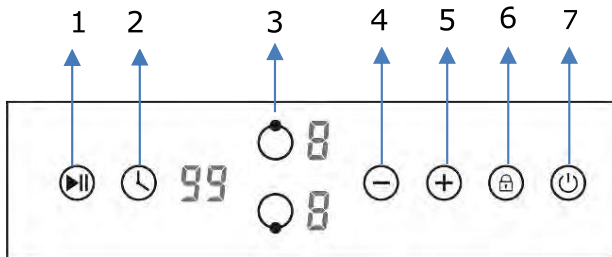

1. Intelligent control button
2. Timer control button
3. Cooking Zone selection button
4. Heating level/Timer "-" button
5. Heating level/Timer "+" button
6. Child Lock control button
7. ON/OFF button

(2) Model: LEH-3218CS

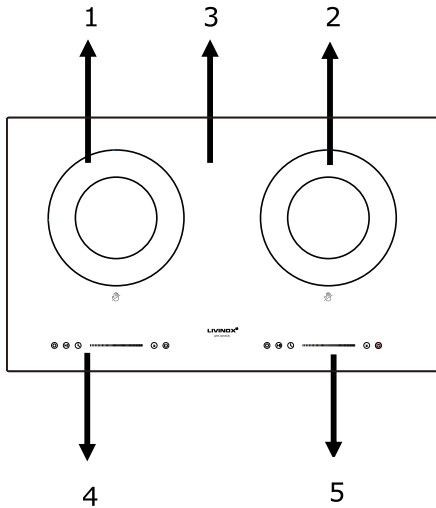

1. 2200/1000W Ceramic Dual Zone
2. 2200/1000W Ceramic Dual Zone
3. Ceramic Glass
4. Control panel of cooking zone#1
5. Control panel of cooking zone#2

Control Panel

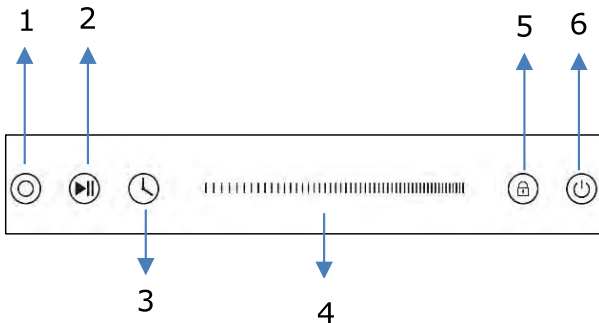

1. Extended zone control button
2. Intelligent control button
3. Timer control button
4. Heating level/Timer adjusting slider
5. Child Lock control button
6. ON/OFF button

(3) Model: LEH-3318CS

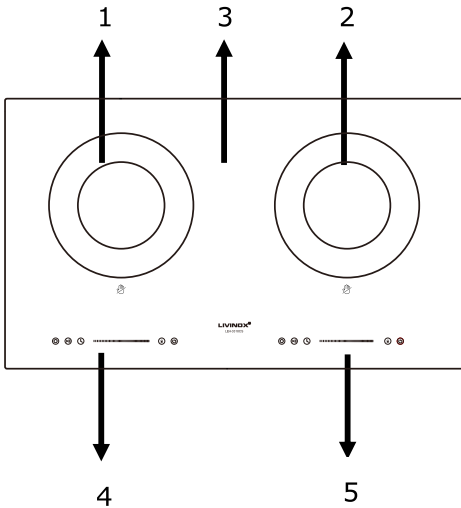

1. 2200/1100W Ceramic Dual Zone
2. 2200/1100W Ceramic Dual Zone
3. Ceramic Glass
4. Control panel of cooking zone#1
5. Control panel of cooking zone#2

Control Panel

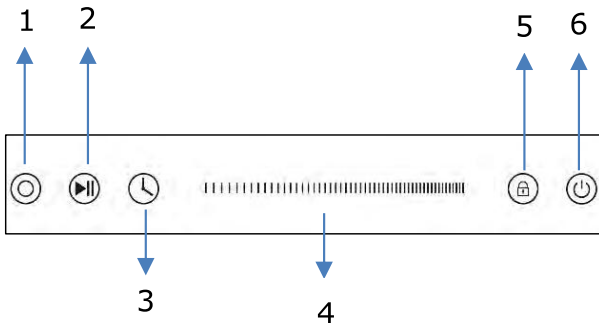

1. Extended zone control button
2. Intelligent control button
3. Timer control button
4. Heating level/Timer adjusting slider
5. Child Lock control button
6. ON/OFF button

(4) Model: LEH-3118CS

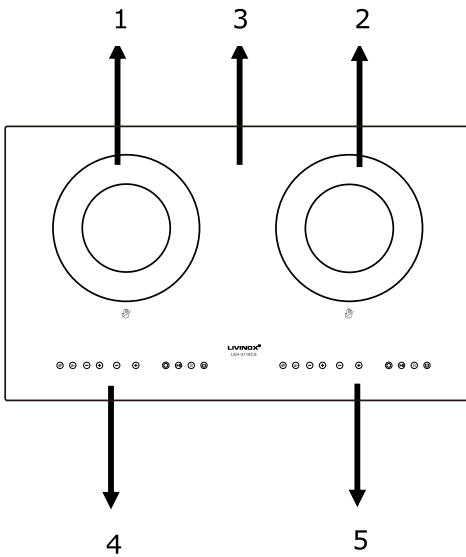

1. 2200/1100W Ceramic Dual Zone
2. 2200/1100W Ceramic Dual Zone
3. Ceramic Glass
4. Control panel of cooking zone#1
5. Control panel of cooking zone#2

Control Panel

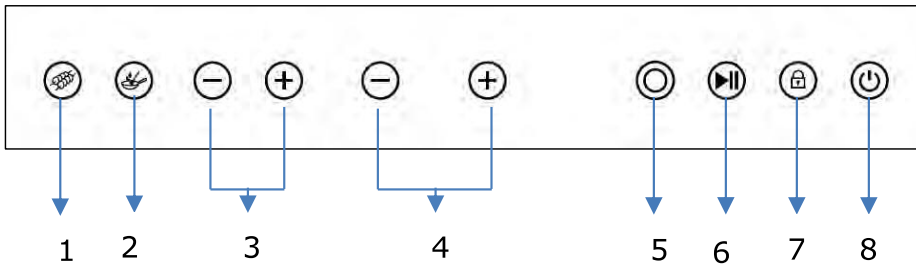

1. BBQ control button
2. Stir fry control button
3. Heating level “-”/ “+” button
4. Timer “-”/ “+” button
5. Extended zone control button
6. Intelligent control button
7. Child Lock control button
8. ON/OFF button

(5) Model: LEH-2000I

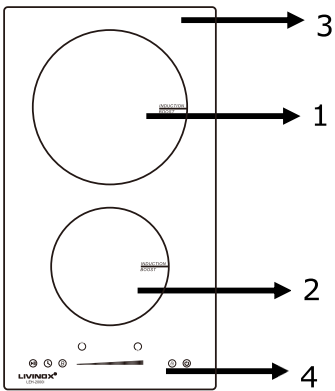

1. 2000W Boost 2600W Induction Zone
2. 1500W Bppst 2000W Induction Zone
3. Glass panel
4. Control panel

Control Panel

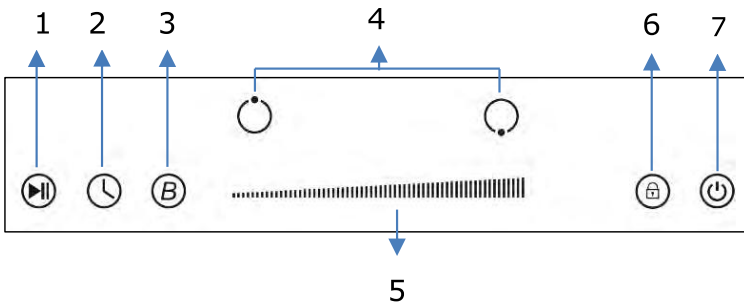

1. Intelligent control button
2. Timer control button
3. Booster control button
4. Cooking Zone selection button
5. Heating level/Timer slider control
6. Child Lock control button
7. ON/OFF button

(6) Model: LEH-4118ICS

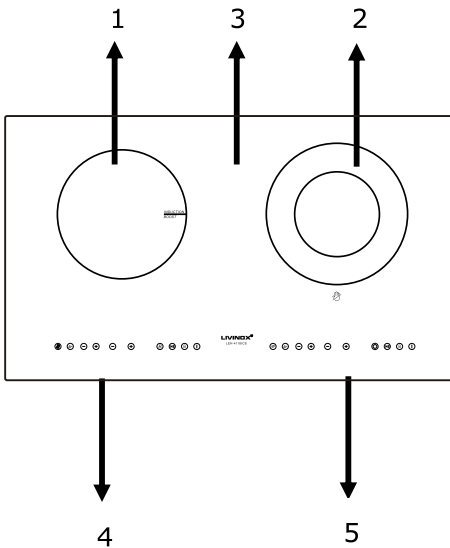

1. 2000W Boost 2200W Induction Zone
2. 2200/1100W Ceramic Dual Zone
3. Ceramic Glass
4. Control panel of cooking zone#1
5. Control panel of cooking zone#2

Control Panel for Induction zone

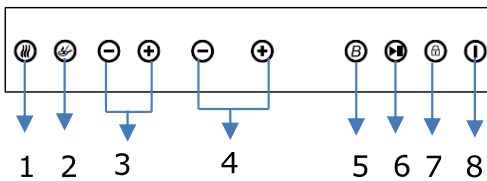

1. Keep Warm control button
2. Stir fry control button
3. Heating level “-”/ “+” button
4. Timer “-”/ “+” button
5. Booster control button
6. Intelligent control button
7. Child Lock control button
8. ON/OFF button

Control Panel for Ceramic zone

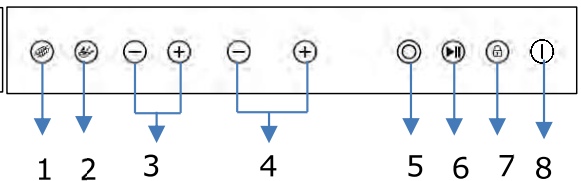

1. BBQ control button
2. Stir fry control button
3. Heating level “-”/ “+” button
4. Timer “-”/ “+” button
5. Extended zone control button
6. Intelligent control button
7. Child Lock control button
8. ON/OFF button

(7) Model: LEH-5118ICS

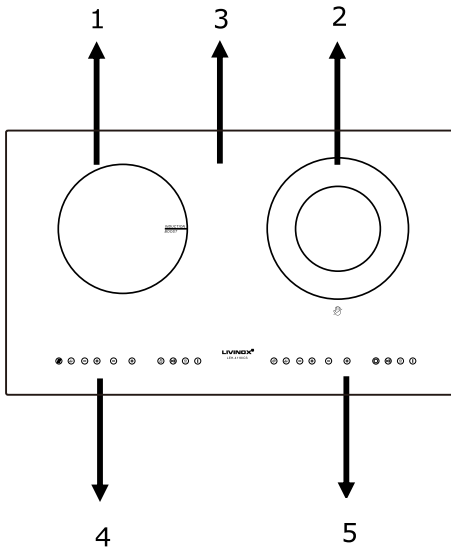

1. 2200W Boost 2800W Induction Zone
2. 2200/1100W Ceramic Dual Zone
3. Ceramic Glass
4. Control panel of cooking zone#1
5. Control panel of cooking zone#2

Control Panel for Induction zone

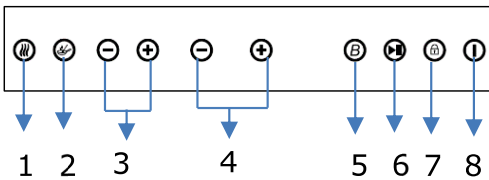

1. Keep Warm control button
2. Stir fry control button
3. Heating level “-”/ “+” button
4. Timer “-”/ “+” button
5. Booster control button
6. Intelligent control button
7. Child Lock control button
8. ON/OFF button

Control Panel for Ceramic zone

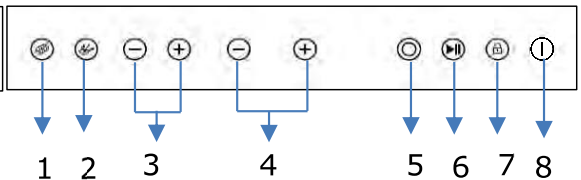

1. BBQ control button
2. Stir fry control button
3. Heating level “-”/ “+” button
4. Timer “-”/ “+” button
5. Extended zone control button
6. Intelligent control button
7. Child Lock control button
8. ON/OFF button

Notes: Product diagrams in this instruction manual for reference only, there might be slightly difference due to continually product improvements.

Before using your New Hob

- Read this manual, taking special note on the 'Safety Warnings' section.
- Remove any protective film that may still be on your new electric hob.

Using the Touch Controls

- The controls respond to touch, so you don't need to apply any pressure.
- Use the ball of your finger, not its tip.
- You will hear a beep each time a touch is registered.
- Make sure the controls are always clean, dry, and that there is no object (e.g. a utensil or a cloth) covering them. Even a thin film of water may make the controls difficult to operate.

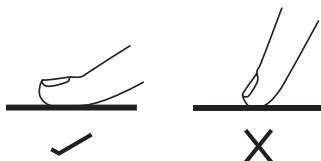

Choose the right Cookware



- Only use cookware with a base suitable for induction cooking. Look for the induction symbol on the packaging or on the bottom of the pan.

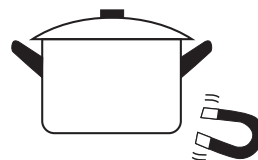

- You can check whether your cookware is suitable by carrying out a magnet test. Move a magnet towards the base of the pan. If it is attracted, the pan is suitable for induction hob.
- If you do not have a magnet:
 1. Put some water in the pan you want to check.
 2. If **U** does not flash in the display and the water is heating, the pan is suitable.
- Cookware made from the following materials is not suitable for an induction hob: pure stainless steel, aluminum or copper without a magnetic base, glass, wood, porcelain, ceramic, and earthenware.
- Induction hobs are made from smooth, ceramic glass, the heat comes from a magnetic induction coil which heats the cookware but not the cooking surface. The heat from the cookware is transferred to the food.
- It's important that you use only metal pans specifically designed and/or approved for use on induction hobs. Never allow melamine or plastic containers to come in contact with the heat zones.

Do not use cookware with jagged edges or a curved base.



Make sure that the base of your pan is smooth, sits flat against the glass, and is the same size as the cooking zone. If you use smaller pot efficiency could be less than expected. Always centre your pan on the cooking zone.

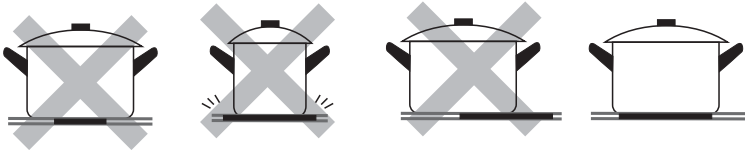

Always lift pans off the electric hob – do not slide, or they may scratch the glass.

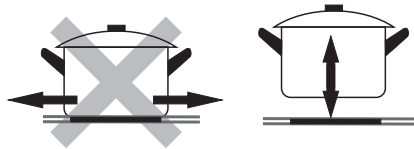

Notes: You can use any kind of pot or pan for Ceramic Hob. Make sure that base of your pot or pan is smooth, sits flat against the ceramic glass, and same size as the cooking zone for better cooking performance.



Using your Hob

To start cooking

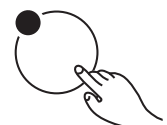
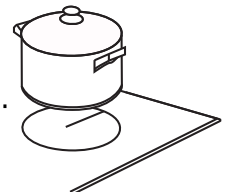
1. After the hob be connected to electricity and power on.
Press and hold the ON/OFF  control button for about 3 seconds till you hear a "beep" to turn the hob on. Now the hob enters into Standby mode, all heat setting indicators and Timer setting indicators shows "--"
 2. Place a suitable pan on the cooking zone that you wish to use.
 - Make sure the bottom of the pan and the surface of the cooking zone are clean and dry.
 3. Set heating level of cooking zone
 - 3.1) **Touch control model LEH-3000C:**
 - 1) Touching the heating zone selection control button to select and active the cooking zone you wish to use. The heat setting indicator of the selected zone will flash





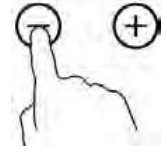

when be active.

2) Then set heat setting by touching the  or  button.



- If press and hold either of the two buttons, the value will adjust down or up rapidly, from 0 to 9 in circle.

3.2. Touch control model LEH-3118CS/LEH-4118ICS/LEH-5118ICS:

1) There is separate  and  heat level control button for each cooking zone for these models. Set heat setting by touching the  or  button for corresponding cooking zone.

3.3) Slider touch control model LEH-2000I:

1) Touching the heating zone selection control button to select and active the cooking zone you wish to use. The heat setting indicator of the selected zone will flash when be active.



2) Adjust heat setting by sliding the slider control.

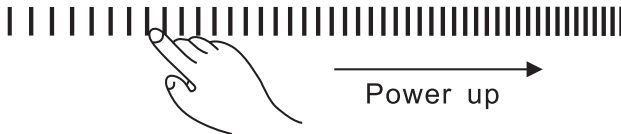

3.4) Slider touch control models LEH-3318CS, LEH-3218CS:

For the model with a touch slider control, you can adjust heat setting by touching the slider control of that cooking zone.

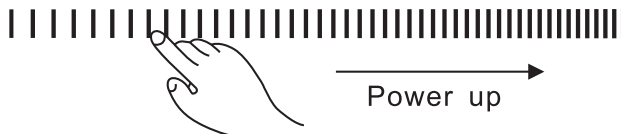

Notes:

1. After connect to electricity, when power on, the buzzer of hob beeps once, all indicators light up for 1 second then turn off.
2. When the hob in Standby mode, if there is not in use within 1 minute, the electric hob will auto turn off, with buzzer beeps once.
3. To turn on hob, press the ON/OFF control button and hold on for about 3 seconds; To turn it off, just need to press ON/OFF button again.
4. You can modify the heat setting at any time during cooking.
5. The default setting of power level is 5, and power level can be adjusted from 0 to 9 in circle (for LEH-3118CS, LEH-4118ICS and LEH-5118ICS, power level can be set from 0 to 12 in circle). The heating element will turn off under power level 0, with indicator shows “-”
6. The heat setting indicator of the selected zone will flash when adjusting. After adjusting, the number in indicator will flash for 5 seconds and then stop flash, then the setting be confirmed.

To turn off hob

1. Touch heating zone selection control button, then turn the cooking zone off by adjust heat setting to 0 level, which indicator shows "-".
2. You can also turn the whole hob off by touching the ON/OFF  control button.

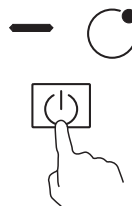

Note: The Timer/Minute Reminder setting will be canceled if hob be turn off.

Note: If there is power cut off during cooking, all programmer setting will be cancelled, you need to reset the program again.

Note: The cooling fan of induction hob will remain on for about 1 minute after the hob be turned off.

Beware of hot surfaces

After turn off, the letter " **H** " will show in the power setting indicator which cooking zone is hot to touch. It will disappear when the surface has cooled down to a safe temperature. It can also be used as an energy saving function if you want to heat further pans, use the hotplate that is still hot.

When in Standby mode, if the surface of cooking zone is hot to touch, the letter "H" and "-" will show in its heat setting indicator alternately.

Note: For LEH-3118CS, LEH-4118ICS, LEH-5118ICS, the Letter "H" will flash in the timer setting 4-digit LED.

Using Large Heating Area-Ceramic Hob

LEH-3218CS, LEH-3318CS and **LEH-3118CS** have one or two extended cooking zones (Dual zone), these extended zones can provide larger cooking area and additional heat. To active the extended zone, please follows below:



To active Extended zone **when hob is working**, please follows below:

1. Select and active cooking zone you would like to use extended zones.

1) **For model LEH-3000C, LEH-2000I:**

Touching the heating zone selection control button to active the cooking zone for adjustment.

2) **For model LEH-3118CS/LEH-4118ICS/LEH-5118ICS:**

Touching the  or  button of corresponding heating zone to active it for adjustment.

3) **For model LEH-3318CS, LEH-3218CS:**



Touch the slider control button of corresponding heating zone to active it for adjustment.

2. The central zone will be switched on, when first adjust of heat level for extended cooking zone.
3. When the heating zone be selected and active (power level indicator flashing), touch extended zone control button  to active extended heating element to get a large heating area.



Notes:

1. By continuous touch the control button, the extended zone work at below consequence:
 - Extended zone: "Central-Dual-Central-Dual-Central zone..."
2. When extended Zone active:
for LEH-3118CS, LEH-4118ICS, LEH-5118ICS the extended zone indicator is on,
for other models, the LED indicator will show heat setting and "  " alternately.

Using Keep Warm-Induction Hob

LEH-4118ICS/LEH-5118ICS comes with Keep Warm function, which makes it very convenient for users to keep food at desired temperature in a period of time.

To active Keep Warm function when hob is working, please follows below:

1. Touching keep warm function button  of the cooking zone you wish to use.
2. The default temperature setting is 45°C while you can press the keep warm function button again to adjust it from 45°C, 65°C, 85°C in circle depend on the temperature you wish.

Notes:

1. In keep warm function, the hob works at default temperature level 45°C.
2. When keep warm function active, the keep warm function indicator is on.
3. By continuous touch the keep warm control button, the cooking zone works at below consequence:

-Cooking zone: "45°C-65°C-85°C-Cancel-45°C-65°C-85°C-Cancel..."



Cancel the Keep Warm function

1. Touching the keep warm control button  again until it cancels the keep warm function, then the cooking zone will revert to its original power setting.
2. You will have to cancel the keep warm function first then you can switch to Stir-fry or Booster function.

Using BBQ-Ceramic Hob

LEH-3118CS, LEH-4118ICS, LEH-5118ICS: comes with BBQ function, which helps you with more convenience when you want to BBQ at home or kitchen.

To active BBQ function **when hob is working**, please follows below:

1. Touching BBQ function button  of the cooking zone you wish to use.
2. The default power is 1000W, while you can press power level setting  or  button to adjust from 400-2200W in circle depend on the power you wish.

Notes:

1. In BBQ function, the hob works at default power level 1000W with extended zone heating, the 4-digit LED shows "1000".
2. When BBQ function active, the BBQ function indicator and extended zone heating indicator are lit up.



Cancel the BBQ function

1. Touching the "BBQ" control button  again to cancel the BBQ function, then the cooking zone will revert to its original power setting.
2. You will have to cancel the BBQ function first then you can switch to Stir-fry function.

Using Stir-fry-Ceramic Hob

LEH-3118CS, LEH-4118ICS, LEH-5118ICS come with Stir-fry function, which could switch cooking zone to maximum temperature level directly, to reduce your cooking time.

To active Stir-fry function **when hob is working**, please follows below:

1. Touching the Stir-fry function button  of the cooking zone you wish to use.
2. The default temperature setting is 550°C, while you can press power level setting  or  button to adjust from 100°C-550°C in circle depend on the temperature you wish.

Notes:

1. In stir-fry function, the hob works at maximum temperature level 550°C with dual zone heating, the 4-digit LED shows "550°C".
2. When Stir-fry function active, the Stir-fry function indicator and extended zone heating indicator are on.

Cancel the Stir-fry function

1. Touching the Stir-fry control button  again to cancel the Stir-fry function, then the cooking zone will revert to its original power setting.
2. You will have to cancel the Stir-fry function first then you can switch to BBQ function.

Using Booster Function-Induction Hob

LEH-2000I have one or two cooking zones which has Booster function. You can use the "Booster" function to boost power of relevant cooking zone for a maximum power rating for 5 minutes. This function could reduce the cooking time, which convenience for cooking when in hurry!

To use booster function when induction hob is working, follows below:

1. Select and active cooking zone you would like to use booster function.

1) For model **LEH-2000I**:

Touching the heating zone selection control button to active the cooking zone for adjustment.



2) For model **LEH-4118ICS, LEH-5118ICS**:

Touch the control button of corresponding heating zone to active it for adjustment.

2. Touch the Booster function control button  , the heating zone indicator will show "b" and flashing for 5 seconds then stop flashing. Then Booster function be activated, the power reach Max for 5 minutes, and then return to the pre-set heat setting.

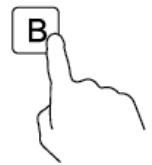

Note:

1. When using booster function, if the other cooking zone in vertical direction also working meanwhile power setting higher than level 2, program will auto turn power setting of the other cooking zone to level 2.
2. After booster finish, the cooking zone will return to original setting.

Cancel the Booster function

1. Select the cooking zone you would like to cancel booster function.
2. Touching the "Booster" control  to cancel the Booster function, then the cooking zone will revert to its original setting.

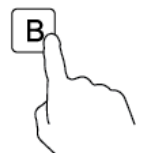

Child Lock Safety Control

- You can lock the controls to prevent unintended use (for example children accidentally turning the cooking zones on) by active Child Lock function.
- When the controls are locked, except the ON/OFF control button and Child Lock control button, all other touch control buttons are disabled.



To lock the controls

Touch the Child Lock control button  once. The timer indicator will show "Lo", and Child Lock function be active.

To unlock the controls

1. Make sure the electric hob is turned on.
2. Touch and hold the Child Lock control button  for around 3 seconds, the buzzer beeps once and "Lo" disappears in timer indicator, the Child Lock be inactive.
3. You can now start using your electric hob.



Under the child lock mode, all controls button are disable except the ON/OFF  and child lock .

You can always turn the hob off with the ON/OFF  control in an emergency, but you shall unlock the hob first in the next operation

Note: Under Child Lock function, if turn the hob off without inactive the Child Lock function. When turn on the hob later, the Child Lock function will still valid.

Intelligent function

- **Make cooking easy!** When cooking, your doorbell rings, phone rings, or kid shouts from another door. Need to step out from kitchen? These means foods could burn, or take longer time to ready if you switch everything off.
- The **Intelligent function** can turn off all zones. When you back, just one touch on button , hob restarts where they were, to carry on cooking.

1. Activate Intelligent function

To activate **Intelligent** function, you can press the **Intelligent** function button once. Then all program setting be paused and hob stop heating, all heat setting indicators show "P".

2. Cancel Intelligent function

To cancel **Intelligent** function, press the **Intelligent** function one more time. Then all program setting will resume to what they were, indicator "P" disappears.



When **Intelligent** function activate, all control buttons are disable except the ON/OFF and Stop & Go button.

Note: The hob will auto turn off, if **Intelligent** function last more than 10 minutes.

Using the Timer

Timer overview

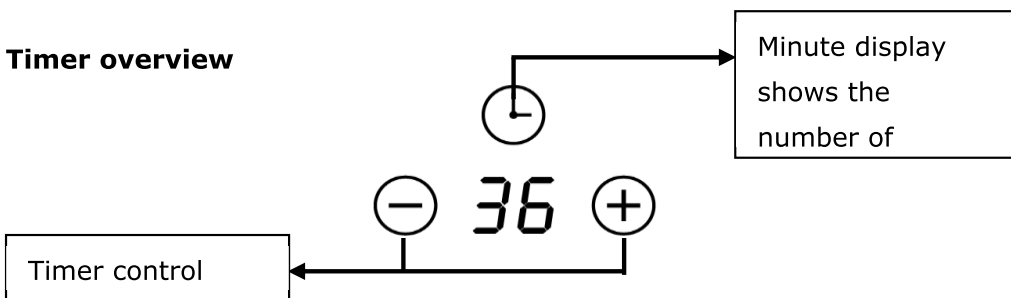

- You can set the minute minder/timer for up to 99 minutes. (24Hours for LEH-3118CS, LEH-4118ICS, LEH-5118ICS)
- For model **LEH-3000C**, **LEH-2000I** you can use the timer in two different ways:

-You can use it as a minute minder.

-You can also set it to turn either or more than one cooking zones off.

Using the Timer as a Minute Minder (model LEH-3000C, LEH-2000I)



If you have not selected any cooking zones

1. Make sure the hob is turned on.
2. Touch the timer control button , the number in timer indicator flashing.



3. Then adjust Minute Minder setting

3.1. For model **LEH-3000C**

- Set heat setting by touching the  or  button.
- If press and hold either of the two buttons, the time will adjust down or up rapidly in circle.

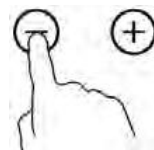

3.2. For model **LEH-2000I**

- Touch the timer control button  once, the number of

single digit in timer indicator flashing, then adjust single digit of minute minder setting by sliding the slider control.

- Press the timer control button again, the number of tens digit in timer indicator flashing, then adjust tens digit of minute minder setting by sliding the slider control.

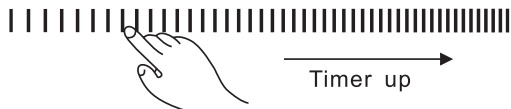

Note: After adjusting, the setting in timer indicator will flash for

5 seconds and then stop flashing, then the setting be confirmed. 

Note: The default setting of Minute Reminder is 30 minutes.

4. When the minute minder is set, it will begin to count down immediately, the display will show the remaining time.
5. Buzzer will beep for 30 seconds and timer indicator shows "- -" when the setting time finished. Any efficient touching of control buttons during it, would end up the buzzer beeps.

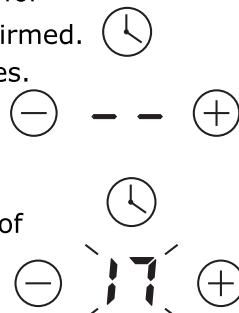



Setting the timer to turn cooking zone off (model LEH-3000C, LEH-2000I)

1. Touch the heating zone selection control button to select the cooking zone you wish to set timer for.
2. Touch the timer control button , the number in timer indicator flashing.



3. Then adjust Timer setting

3.1. For model LEH-3000C

- Set heat setting by touching the  or  button.
- If press and hold either of the two buttons, the time will adjust down or up rapidly in circle.

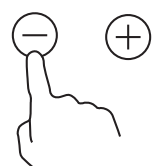

3.2. For model LEH-2000I

- Touch the timer control button  once, the number of single digit in timer indicator flashing, then adjust single digit of minute minder setting by sliding the slider control.
- Press the timer control button again, the number of tens digit in timer indicator flashing, then adjust tens digit of minute minder setting by sliding the slider control.



Note: After adjusting, the setting in timer indicator will flash for 5 seconds and then stop flashing, then the setting be confirmed.

Note: The default setting of timer is 30 minutes.

- When the timer is set, it will begin to count down immediately, the display will show the remaining time.

NOTE: The red dot next to power level indicator will illuminate for those zones be set with timer. You can check timer setting of different cooking zone which set with timer, by press corresponding cooking zone select button.

NOTE: If more than one heating zone has timer setting, the timer indicator will show the lowest time. The red dot next to power level indicator will flash.

- When cooking timer expires, the corresponding cooking zone will be switch off automatically.

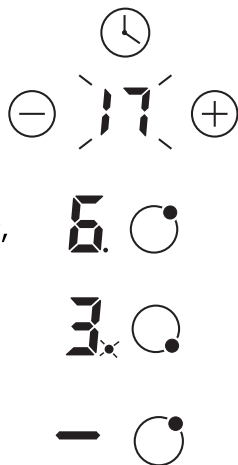

Note: For **model LEH-3000C, LEH-2000I**, the minute reminder and timer can be use at same time, the timer indicator will show the lowest time setting. If the lowest setting is minute reminder, the red dot next to timer indicator will flash. If the lowest setting is timer setting, the red dot of corresponding cooking zone power level indicator will flash.

Note: If indicator shows timer setting of cooking zone. To check minute reminder setting, press the timer control button , the indicator will show minute reminder setting.



Setting the timer to turn cooking zone off

(model LEH-3118CS, LEH-3318CS, LEH-3218CS, LEH-4118ICS and LEH-5118ICS)

For these models, each cooking zone be controlled by a separate display PCB.

- For **model LEH-3118CS, LEH-4118ICS, LEH-5118ICS**

Directly touch the  or  button of timer to active it.

- Set timer setting by touching the  or  button.
- If press and hold either of the two buttons, the value will adjust down or up rapidly in circle.

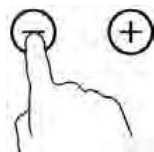

- For **model LEH-3318CS, LEH-3218CS**

1. Touch the timer control button  for the cooking zone, the number in timer indicator flashing, then you can adjust timer setting of the cooking zone to turn it off.



2. Adjust Timer setting

- Touch the timer control button  once, the number of single digit in timer indicator flashing, then adjust single digit of minute minder setting by sliding the slider control.
- Press the timer control button again, the number of tens digit in timer indicator flashing, then adjust tens digit of minute minder setting by sliding the slider control.

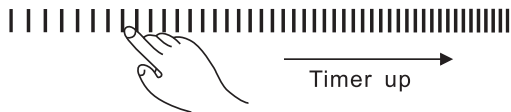

Note: By continuous touch the timer control button, the slider works at below consequence: "Single Digit-Tens Digit-Confirm Setting-Single Digit-..."

Note: After adjusting, the setting in timer indicator will flash for 5 seconds and then stop flashing, then the setting be confirmed.

Note: The default setting of timer is 30 minutes.

3. When the timer is set, it will begin to count down immediately, the display will show the remaining time.
4. When cooking timer expires, the corresponding cooking zone will be switch off automatically.

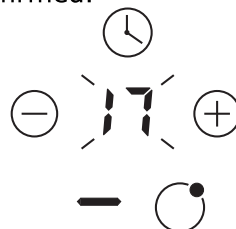

Residual Heat Warning

When the hob has been operating for some time, there will be some residual heat. The letter " H " appears to warn you to keep away from it.



Auto Shutdown

Another safety feature of the hob is auto shutdown. This occurs whenever you forget to switch off a cooking zone.

For all models, the default shutdown times (hour) as below table:

Power level	1	2	3	4	5	6	7	8	9
Default working time	8	8	8	4	4	4	2	2	2

For LEH-3118CS, LEH-4118ICS, LEH-5118ICS, the default shutdown times (hour) as below table:

Power level	1	2	3	4	5	6	7	8	9	10	11	12
Default working time	8	8	8	8	4	4	4	4	2	2	2	2

A temperature sensor equipped can monitor the temperature inside the hob. When an excessive temperature is monitored, the hob will auto stop operation.

Over-flow Protection

For your safety, the program will auto shut off the power if liquid boiling or wet cloth over the touch control panel. All control buttons became invalid except ON/OFF and Child Lock button, unless you wipe the touch control area to keep it dry.

Detection of Pan and Small Articles

For induction hob, if the display flashes “” alternately with heat setting.

- you have not placed a pan on the correct cooking zone or,
- the pan you are using is not suitable for induction cooking or,
- the pan is too small or not properly centered on the cooking zone.

Notes:

1. No heating takes place unless there is a suitable pan placed on the cooking zone.
2. The display will auto turn off after 2 minutes if no suitable pan is placed on it.
3. When an unsuitable size or non-magnetic pan (e.g. aluminum), or some other small item (e.g. knife, fork, key) has been left on the hob, the hob automatically go to standby in 1 minute. The fan will auto on to cooling down the induction hob for a further 1 minute.

Cooking Guidelines

Cooking Tips

- When food boiling, reduce the power setting.
- Using a lid will reduce cooking times and save energy by retaining the heat.
- Minimize the amount of liquid or fat to reduce cooking times.
- Start cooking on a high setting and reduce the setting when the food has heated through.

Simmered/stew, cook rice

- To have a perfect cooking method, it is advisable to keep temperature at around 85°C while stew/simmered food/soup. It will make your food/soup well develop without overcook. Cook egg, thickened sauces below boiling point.
- Some tasks, including cooking rice by absorption method, may require a

setting higher than the lowest setting to ensure the food is cooked properly at the time recommended.

Searing steak

To cook juicy flavorsome steaks:

1. Place the meat at room temperature for about 20 minutes before cooking.
2. Heat up a heavy-based frying pan.
3. Brush both sides of the steak with oil. Drip a small amount of oil into the hot pan and place the meat onto the hot pan.
4. Turn the steak only once during cooking. The exact cooking time will depend on the thickness of the steak and your choice of steak doneness. Times may vary from about 2 – 8 minutes per side.

For stir-frying

1. Choose a ceramic compatible flat-based wok or a large frying pan.
2. Have all the ingredients and equipment ready. Stir-frying should be done quick in order to keep the food fresh.
3. Stir the ingredients gently to make sure they are heated through.
4. Serve immediately.

Part 4. Cleaning and Maintenance

Cleaning and Maintenance

Important: Before any maintenance or cleaning work is carried out, DISCONNECT the appliance from ELECTRICITY supply and ensure the appliances is completely cool.

Cleaning the Hob Surface

Clean spillages from the hob surface as soon as possible after use. Always ensure the surface is cool enough before cleaning.

Use a soft cloth or kitchen towel to clean the surface. If the spillage has dried on the surface, you may need to use a specialist vitro-ceramic glass cleaner, which is available from most of supermarkets.

Do not use other abrasive cleaners and/or wire wool etc., as it may scratch the ceramic glass surface of your hob.

Cleaning and Maintenance

Trouble	Resolve	Important!
<p>Everyday soiling on glass (fingerprints, marks, stains left by food or non-sugary spillovers on the glass)</p>	<ol style="list-style-type: none"> 1. Switch off the power supply. 2. Apply a vitro-ceramic glass cleaner while the glass is still warm (but not hot!) 3. Rinse and wipe dry with a clean cloth or kitchen towel. 4. Switch on the power supply to the hob. 	<ul style="list-style-type: none"> • When turn off the power supply of hob, there will be no 'hot surface' indication but the cooking zone may still be hot! Take extreme care. • Heavy-duty scourers, some nylon scourers and harsh/abrasive cleaning agents may scratch the glass. Always read the label to check if your cleaner or scourer is suitable. • Never leave cleaning residue on the hob glass surface: the glass may become stained.
<p>Boil over, melts, and hot sugary spills on the glass</p>	<p>Remove these immediately with a fish slice, palette knife or razor blade scraper suitable for ceramic glass of hob, but beware of hot cooking zone surfaces:</p> <ol style="list-style-type: none"> 1. Switch off the power supply. 2. Hold the blade or utensil at a 30 ° angle and scrape the soiling or spill to a cool area of the hob. 3. Clean the soiling or spill up with a clean cloth or kitchen towel. 4. Follow steps 2 to 4 for 'Everyday soiling on glass' above. 	<ul style="list-style-type: none"> • Remove stains left by melts and sugary food or spillovers as soon as possible. Otherwise, they may be difficult to remove or even permanently damage the glass surface. • Cut hazard: when the safety cover is retracted, the blade in a scraper is razor-sharp. Use with extreme care and always store safely and out of reach of children.
<p>Spillovers on the touch controls</p>	<ol style="list-style-type: none"> 1. Switch off the power supply. 2. Soak up the spill 3. Wipe the touch control area with a clean damp sponge or cloth. 4. Wipe the area completely dry with a kitchen towel. 5. Switch on the power supply to the hob. 	<ul style="list-style-type: none"> • The hob may beep and turn itself off, and the touch controls may not function while there is liquid on them. Make sure you wipe the touch control area dry before turning the hob on.

Trouble-shooting Guide

1. There is no power to the appliance:
 - Check whether there is a power cut off on current;
 - Check whether the appliance be connected to electricity properly;
 - Has the timer setting elapsed;
 - Whether it reaches the longest cooking time setting and auto shut off;
 - Whether there is liquid boiling over touch control panel and overflow protection devices auto shut off;
2. The touch control panel buttons can't be activate:
 - Whether it's under "Child Lock", which there is "Lo" shows in timer displayer;
 - Whether liquid/wet cloth over touch control panel may result overflow protection be activate;
3. After cooking there is "H" shows on display:
 - This is normal. The hob is with Residual Heat Warning safety features. It will remain on until the surface is cool enough for touch.
4. After turn off, the fan of induction hob remains working for a while:
 - This is normal, this is to help appliances completely cool down.
5. Some pans make crackling or clicking noises during use of induction hob:
 - This is normal, it's the sound of induction coils during working, and for different construction of your cookware, the clicking might be slightly different.
6. The glass is being scratched:
 - Check whether you use unsuitable cookware, like rough-edged cookware.
 - Check whether unsuitable, abrasive scourer or cleaning products being used.

**** Contact your Service Provider if the above problem is unable to resolve.**

Failure Inspection for induction hob

If an abnormality comes up, the induction hob will enter the protective state automatically and display corresponding protective codes:

Problem	Possible causes	What to do
E1/E2	Abnormal supply voltage	Please check whether power supply is normal, Power on after the power supply is normal.
E3	High temperature of the pan sensor	Check whether no liquid in pan, fill with liquid then restart.
E5	High temperature of the IGBT temperature sensor	Please restart after the induction hob cools down.

For all other error codes, switch off and call your service provider.

LIVINOX[®]

LIVINOX Malaysia Sdn Bhd
Blok B-1-29 Dataran Cascades
No.13A, Jalan PJU 5, Kota Damansara,
47810 Petaling Jaya, Selangor

